



Minuto

USER MANUAL

Type HD8662, HD8665

Read carefully before using the machine.



EN

02



Register your product and get support at
www.saeco.com/welcome

IMPORTANT SAFEGUARDS

When using electrical appliances, basic safety precautions should always be followed, including the following:

1. Read all instructions.
2. Do not touch hot surfaces. Use handles or knobs.
3. To protect against fire, electric shock and injury to persons do not immerse cord, plugs, or appliance in water or other liquid.
4. Close supervision is necessary when the appliance is used by or near children.
5. Unplug from outlet when not in use and before cleaning. Allow to cool before putting on or taking off parts, and before cleaning the appliance.
6. Do not operate any appliance with a damaged cord or plug or after the appliance malfunctions, or has been damaged in any manner. Return appliance to the nearest authorized service facility for examination, repair or adjustment.
7. The use of accessory attachments not recommended by the appliance manufacturer may result in fire, electric shock or injury to persons.
8. Do not use outdoors.
9. Do not let cord hang over edge of table or counter, or touch hot surfaces.
10. Do not place on or near a hot gas or electric burner, or in a heated oven.
11. Always attach plug to appliance first, then plug cord into wall outlet. To disconnect, turn any control to "off", then remove plug from wall outlet.
12. Do not use appliance for other than intended use.
13. Save these instructions.

SAVE THESE INSTRUCTIONS

CAUTION

This appliance is for household use only. Any servicing, other than cleaning and user maintenance, should be performed by an authorized service center. Do not immerse machine in water. To reduce the risk of fire or electric shock, do not disassemble the machine. There are no parts inside the machine serviceable by the user. Repair should be done by authorized service personnel only.

1. Check voltage to be sure that the voltage indicated on the nameplate corresponds with your voltage.
2. Never use warm or hot water to fill the water tank. Use cold water only.
3. Keep your hands and the cord away from hot parts of the appliance during operation.
4. Never clean with scrubbing powders or harsh cleaners. Simply use a soft cloth dampened with water.
5. For optimal taste of your coffee, use purified or bottled water. Periodic descaling is still recommended every 2-3 months.
6. Do not use caramelized or flavored coffee beans.

INSTRUCTIONS FOR THE POWER SUPPLY CORD

- A. A short power-supply cord (or detachable power-supply cord) is to be provided to reduce risks resulting from becoming entangled in or tripping over a longer cord.
- B. Longer detachable power-supply cords or extension cords are available and may used if care is exercised in their use.
- C. If a long detachable power-supply cord or extension cord is used,
 1. The marked electrical rating of the detachable power-supply cord or extension cord should be at least as great as the electrical rating of the appliance
 2. If the appliance is of the grounded type, the extension cord should be a grounding-type 3-wire cord, and
 3. The longer cord should be arranged so that it will not drape over the counter top or table top where it can be pulled on by children or tripped over.

Congratulations on your purchase of a Saeco Minuto Automatic Milk Frother fully automatic coffee machine!

*To fully benefit from the support that Saeco offers, please register your product at **www.saeco.com/welcome**.*

The machine is suitable for preparing espresso coffee using whole coffee beans.

In this user manual you will find all the information you need to install, use, clean and descale your machine.

CONTENTS

IMPORTANT	4
Safety Instructions	4
Warnings.....	4
Cautions	6
Electromagnetic Fields	7
Disposal	7
INSTALLATION	8
Product Overview.....	8
General Description.....	9
PREPARING FOR USE	10
Machine Packaging.....	10
Machine Installation	10
USING THE MACHINE FOR THE FIRST TIME	12
Circuit Priming	12
Automatic Rinse/Self-Cleaning Cycle.....	13
Manual Rinse Cycle.....	14
Measuring and Programming Water Hardness	16
"INTENZA+" Water Filter Installation	17
ADJUSTMENTS	19
Saeco Adapting System.....	19
Adjusting the Ceramic Coffee Grinder.....	19
Adjusting the Coffee Dispensing Spout	20
Adjusting the Coffee Length	22
BREWING ESPRESSO AND COFFEE	23
FROTHING MILK / BREWING CAPPUCCINO	24
Frothing milk	24
Brewing a Cappuccino.....	27
HOT WATER DISPENSING	27
CLEANING AND MAINTENANCE	29
Daily Cleaning of the Machine.....	29
Daily Cleaning of the Water Tank	30
Daily Cleaning of the Automatic Milk Frother	31
Weekly Cleaning of the Machine	32
Weekly Cleaning of the Brew Group	32
Monthly Cleaning of the Automatic Milk Frother	36
Monthly Lubrication of the Brew Group	42
Monthly Cleaning of the Coffee Bean Hopper.....	43
DESCALING	44
INTERRUPTION OF THE DESCALING CYCLE	50
CONTROL PANEL WARNINGS	53
TROUBLESHOOTING	57
ENERGY SAVING	59
Stand-by	59
TECHNICAL SPECIFICATIONS	60
WARRANTY AND SERVICE	60
Warranty	60
Service	60
ORDERING MAINTENANCE PRODUCTS	61

IMPORTANT

Safety Instructions

This machine is equipped with safety devices. Nevertheless, read and follow the safety instructions carefully and only use the machine properly as described in these instructions to avoid accidental injury or damage due to improper use of the machine. Keep this user manual for future reference.



The term **WARNING** and this icon warn against possible severe injuries, danger to life and/or damage to the machine.



The term **CAUTION** and this icon warn against slight injuries and/or damage to the machine.

Warnings

- Connect the machine to a wall socket with a voltage matching the technical specifications of the machine.
- Connect the machine to an earthed wall socket.
- Do not let the power cord hang over the edge of a table or counter, or touch hot surfaces.
- Never immerse the machine, the mains plug or power cord in water: Danger of electrical shock!
- Do not pour liquids on the power cord connector.
- Never direct the hot water jet towards body parts: Danger of burning!
- Do not touch hot surfaces. Use handles and knobs.
- After switching off the machine by pressing the power button on the back of the machine, remove the mains plug from the wall socket:
 - if a malfunction occurs;
 - if the machine will not be used for a long time;

- before cleaning the machine.
- Pull on the mains plug, not on the power cord.
- Do not touch the mains plug with wet hands.
- Do not use the machine if the mains plug, the power cord or the machine itself is damaged.
- Do not make any modifications to the machine or its power cord. Only have repairs carried out by a service centre authorised by Philips to avoid any hazard.
- The machine should not be used by children younger than 8 years old.
- The machine can be used by children of 8 years and upwards if they have previously been instructed on the correct use of the machine and made aware of the associated dangers or if they are supervised by an adult.
- Cleaning and maintenance should not be carried out by children unless they are more than 8 years old and supervised by an adult.
- Keep the machine and its power cord out of reach of children under 8 years old.
- The machine may be used by persons with reduced physical, sensory or mental capabilities or lacking sufficient experience and/or skills if they have previously been instructed on the correct use of the machine and made aware of the associated dangers or if they are supervised by an adult.
- Children should be supervised to ensure that they do not play with the machine.
- Never insert fingers or other objects into the coffee grinder.

Cautions

- The machine is for household use only. It is not intended for use in environments such as canteens, staff kitchens of shops, offices, factories or other work environments.
- Always put the machine on a flat and stable surface.
- Do not place the machine on hot surfaces, directly next to a hot oven, heater units or similar sources of heat.
- Only put roasted coffee beans into the coffee bean hopper. If ground coffee, instant coffee, raw coffee or any other substance is put in the coffee bean hopper, it may damage the machine.
- Let the machine cool down before inserting or removing any parts. The heating surfaces may retain residual heat after use.
- Never use warm or hot water to fill the water tank. Use only cold non-sparkling drinking water.
- Never clean with scrubbing powders or harsh cleaners. Simply use a soft cloth dampened with water.
- Descale your machine regularly. Not doing this will make your appliance stop working properly. In this case repair is not covered under your warranty!
- Do not keep the machine at temperature below 0 °C. Residue water in the heating system may freeze and cause damage.
- Do not leave water in the water tank if the machine is not used over a long period of time. The water can get contaminated. Use fresh water every time you use the machine.

Electromagnetic Fields

This appliance complies with all the applicable standards and regulations relating to the exposure to electromagnetic fields.

Disposal



This symbol on a product indicates that the product is covered by EU Directive 2012/19/EU. Please inform yourself about the local separate collection system for electrical and electronic products. Follow local regulations and do not dispose of the product as household waste. Appropriate disposal of old products helps prevent negative consequences for the environment and human health.

INSTALLATION

Product Overview

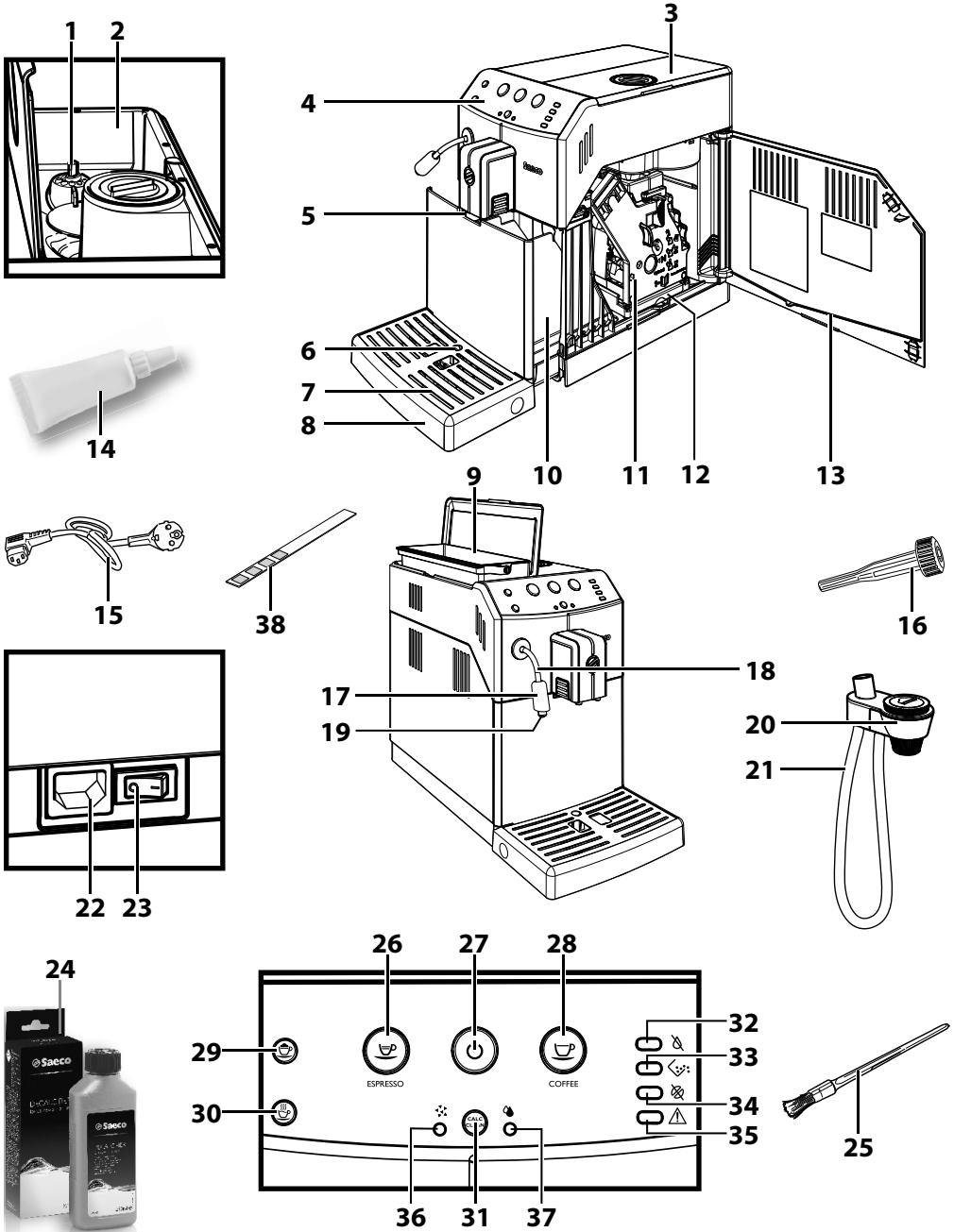

General Description

1. Grinder adjustment knob
2. Coffee bean hopper
3. Coffee bean hopper lid
4. Control panel
5. Coffee dispensing spout
6. Full drip tray indicator
7. Cup holder grill
8. Drip tray
9. Water tank + Lid
10. Coffee grounds drawer
11. Brew group
12. Coffee residues drawer
13. Service door
14. Grease for brew group - (optional)
15. Power cord
16. Coffee grinder adjustment key
17. Chrome cover
18. Steam wand
19. Rubber fitting
20. Automatic Milk Frother
21. Suction tube for Automatic Milk Frother
22. Power cord socket
23. Power button
24. Descaling solution - to be purchased separately
25. Cleaning brush - (optional)
26. Espresso brew button
27. ON/OFF button
28. Long coffee brew button
29. Cappuccino button
30. Hot water button
31. Descaling button
32. No water light
33. Empty coffee grounds drawer light
34. No coffee light
35. General warning light
36. Descaling cycle light
37. Rinse cycle light
38. Water hardness test strip

PREPARING FOR USE

Machine Packaging

The original packaging has been designed and constructed to protect the machine during transport. We recommend keeping the packaging material for possible future transport.

Machine Installation

1 Remove the machine from the packaging.

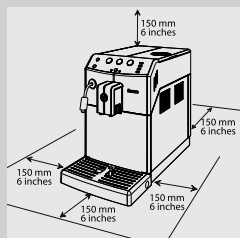

2 For best use, it is recommended to:

- Choose a safe, level surface where there will be no danger of overturning the machine or being injured.
- Choose a location that is sufficiently well-lit, clean and near an easily reachable socket.
- Allow for a minimum distance from the sides of the machine as shown in the figure.

3 Open the water tank lid.

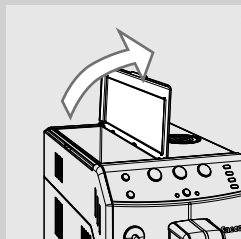

4 Remove the water tank using the handle.

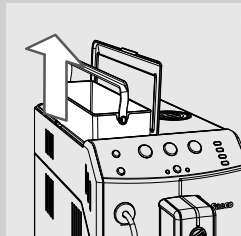

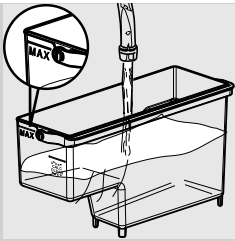

5 Rinse the water tank with fresh water.

6 Fill the water tank with fresh water up to the MAX level and reinsert it into the machine. Make sure it is fully inserted.



Caution:

Never fill the water tank with warm, hot, sparkling water or any other liquid, as this may cause damage to the water tank and the machine.

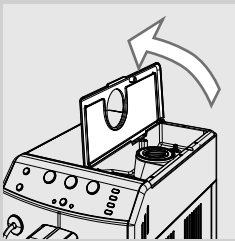

7 Lift the coffee bean hopper lid.

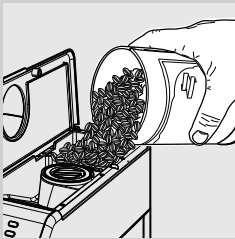

8 Slowly pour the coffee beans into the coffee bean hopper.



Note:

Do not pour too many coffee beans into the coffee bean hopper as this will reduce the grinding performance of the machine.



Caution:

Only coffee beans must be put into the coffee bean hopper. If ground coffee, instant coffee, caramelized coffee, raw coffee beans or any other substance is put in the coffee bean hopper, it may damage the machine.

9 Put the lid back on the coffee bean hopper.

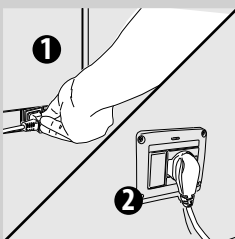

10 Insert the plug into the socket located on the back of the machine.

11 Insert the plug on the other end of the power cord into a wall socket with suitable power voltage.

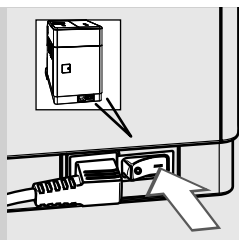

12 Switch the power button to "I". The "⏻" button flashes.



13 To turn on the machine, simply press the "⏻" button.

USING THE MACHINE FOR THE FIRST TIME

When using the machine for the first time, the following activities need to happen:

- 1) you need to prime the circuit;
- 2) the machine will perform an automatic rinse/self-cleaning cycle;
- 3) you need to perform a manual rinse cycle.

Circuit Priming

During this process, fresh water flows through the internal circuit of the machine and the machine warms up. This takes a few minutes.

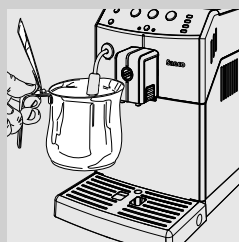

1 Place a container under the steam wand.

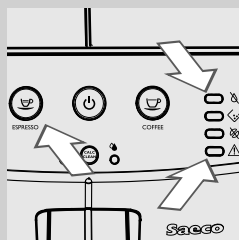

2 The "☉" light and the "⚠" light flash simultaneously; then the "☕" button lights up.
To prime the circuit, press the "☕" button.

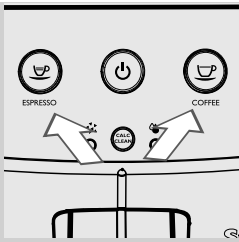

- 3** Thereafter, the machine warms up; the "☺" and "☺" buttons flash simultaneously.

Automatic Rinse/Self-Cleaning Cycle

When the warm-up phase has been completed, the machine automatically performs a rinse/self-cleaning cycle of the internal circuits with fresh water. This takes less than a minute.

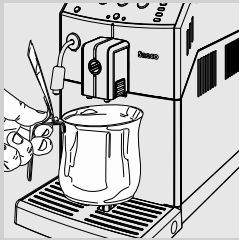

- 1** Place a container under the coffee dispensing spout to catch the water which will be dispensed.

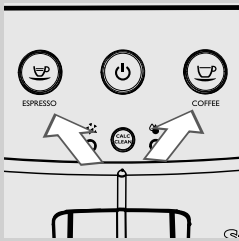

- 2** The "☺" and "☺" buttons flash simultaneously. Wait for the cycle to finish automatically.

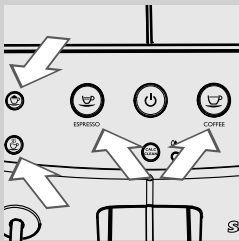

- 3** When the operations described above have been completed, the "☺", "☺", "☺" and "☺" buttons shine steadily. You can now perform the manual rinse cycle.

Manual Rinse Cycle

During this process, the coffee brewing cycle is activated and fresh water flows through the water circuit. This takes a few minutes.

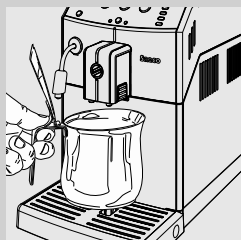

- 1 Place a container under the coffee dispensing spout.

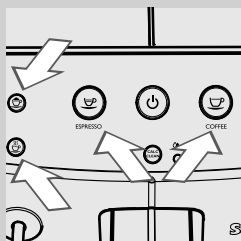

- 2 Check that the "☕", "☕", "☕" and "☕" buttons are shining steadily.



- 3 Press the "☕" button. The machine starts brewing coffee. Wait until brewing has been completed and empty the container.



- 4 Place a container under the steam wand.

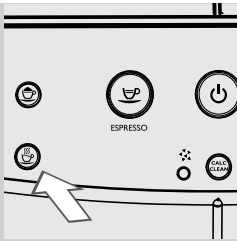

5 Press the “☕” button to start dispensing hot water. The button flashes during dispensing.

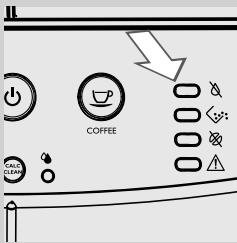

6 Dispense all the remaining water. The “☕” light shines steadily.

Note:

If you want to interrupt the manual rinse cycle (for example to empty the container), press the “☕” button; to resume press the “☕” button again.

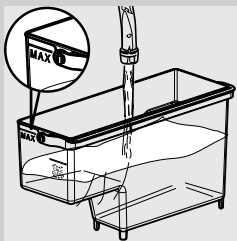

7 Fill the water tank again up to the MAX level. Now the machine is ready to brew coffee.

Note:

The automatic rinse/self-cleaning cycle starts when the machine has been in stand-by mode, or turned off, for more than 15 minutes. When you have not used the machine for 2 or more weeks, you will need to perform a manual rinse cycle. At the end of the cycle, you can brew a coffee.

Measuring and Programming Water Hardness

Water hardness measuring is very important in order to define the descaling frequency and to install the "INTENZA+" water filter (for more details on the water filter, see next chapter).

To measure the water hardness follow the steps below:

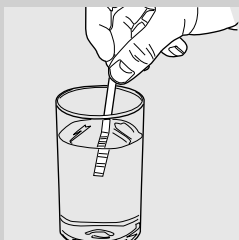

- 1 Immerse the water hardness test strip (supplied with the machine) in water for 1 second.



Note:

The test strip can only be used for one single measurement.

- 2 Wait for one minute.

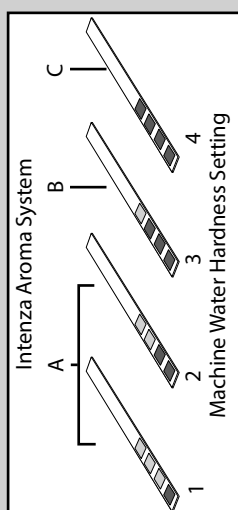

- 3 Check how many squares have changed colour to red and then refer to the table.



Note:

The numbers on the water hardness test strip correspond to the water hardness.

More precisely:

- 1 = 1 (very soft water)
- 2 = 2 (soft water)
- 3 = 3 (hard water)
- 4 = 4 (very hard water)

The letters correspond to the references that are located at the base of the "INTENZA+" water filter (see next chapter).

“INTENZA+” Water Filter Installation

We recommend you to install the “INTENZA+” water filter as this prevents limescale build-up in your machine and preserves a more intense aroma of your coffee.



The “INTENZA+” water filter can be purchased separately. For further details, please refer to the maintenance products page in this user manual. Water is a crucial part of every coffee, so it is very important to always have it professionally filtered. Using the “INTENZA+” water filter will prevent mineral deposits from building up and improve your water quality.



- 1** Remove the small white filter from the water tank and store it in a dry place.

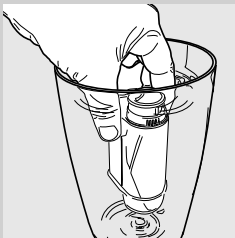

- 2** Remove the “INTENZA+” water filter from its packaging, immerse it vertically (with the opening positioned upwards) in cold water and gently press the sides so as to let the air bubbles out.

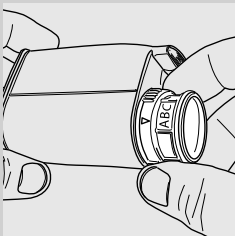

- 3** Set the “INTENZA+” water filter according to the measurements performed (see previous chapter) and indicated on the base of the filter:
 A = soft water – equals 1 or 2 on the test strip
 B = hard water (standard) – equals 3 on the test strip
 C = very hard water – equals 4 on the test strip

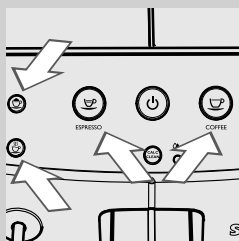

4 Put the "INTENZA+" water filter into the empty water tank. Press it down until it cannot move any further.

5 Fill the water tank with fresh water and put it into the machine.

6 Check that the "☕", "☕", "☕" and "☕" buttons are shining steadily.

7 Press the "☕" button to start dispensing hot water. The button flashes during dispensing.

8 Dispense all water in the tank. The "☕" light shines steadily.

9 Fill the water tank again with fresh water and reinsert it into the machine.

10 When the operations described above have been completed, the "☕", "☕", "☕" and "☕" buttons shine steadily.

Note:

The "INTENZA+" water filter must be replaced after two months of use.

ADJUSTMENTS

The machine allows for certain adjustments so that you can brew the best tasting coffee possible.

Saeco Adapting System

Coffee is a natural product and its characteristics may change according to its origin, blend and roast. The machine is equipped with a self-adjusting system that allows the use of all types of coffee beans available on the market, except for raw, caramelized and flavoured coffee beans.

The machine automatically adjusts itself after brewing several cups of coffee to optimize coffee extraction.

Adjusting the Ceramic Coffee Grinder

Ceramic coffee grinders always guarantee accurate and perfect grinding and coarseness for every coffee speciality.

This technology provides full aroma preservation, delivering a truly Italian taste in every cup.



Warning:

The ceramic coffee grinder contains moving parts that may be dangerous. Do not insert fingers or other objects. Only adjust the ceramic coffee grinder using the grinder adjustment key.

You can adjust the ceramic grinders to set the coffee grinding to your personal taste.



Warning:

You can only adjust the coffee grinder settings when the machine is grinding coffee beans.



- 1 Place a cup under the coffee dispensing spout.
Press the “☺” button to brew an espresso.

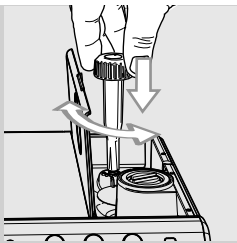

- 2** While the machine grinds coffee, press and turn the grinder adjustment knob placed inside the coffee bean hopper one notch at a time. Use the special coffee grinder adjustment key supplied. You will taste the difference after brewing 2-3 cups of coffee.

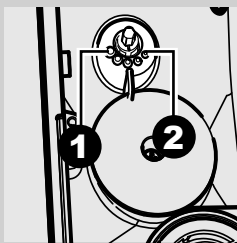

- 3** The reference marks inside the coffee bean hopper indicate the grind setting. There are 5 different grind settings to choose from, from position 1 (●) for coarse grind - lighter taste to position 2 (●) for fine grind - stronger taste. If coffee is watery or is brewed slowly, change the coffee grinder settings.

Adjusting the Coffee Dispensing Spout

The height of the coffee dispensing spout can be adjusted to better fit the dimensions of the cups that you wish to use.

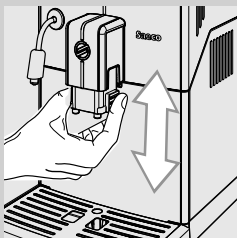

Move the coffee dispensing spout up or down with your fingers to adjust its height as shown in the figure.

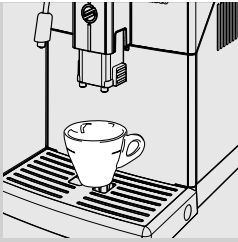

The recommended positions are:
For the use of small cups;



For the use of large cups.

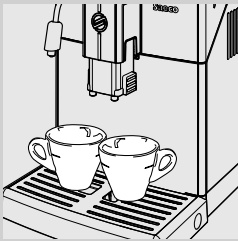

Two cups can also be placed under the coffee dispensing spout to brew two cups of espresso or two cups of long coffee at the same time.

Adjusting the Coffee Length

The machine allows you to adjust the amount of brewed coffee according to your taste and the size of your cups.

Each time the “☺” or “☹” button is pressed, the machine brews a pre-set amount of coffee. Each button may be individually programmed for a specific brew setting.

The following procedure describes how to program the “☺” button.

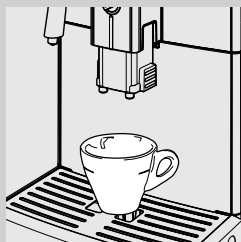

- 1 Place a cup under the coffee dispensing spout.

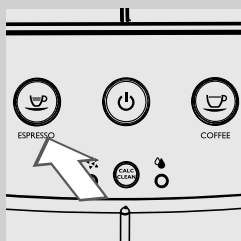

- 2 Press and hold the “☺” button until it starts to flash quickly. Then release the button. The machine is now in programming mode. The “☺” button flashes throughout the programming cycle. The machine starts brewing coffee.

- 3 Press the “☺” button as soon as the desired amount of coffee is reached.

Now the button “☺” is programmed; each time it is pressed, the machine will brew the same amount of espresso that was just programmed.



Note:

Follow the same procedure to program the “☹” button.

Press the “☹” button to stop brewing when the desired amount of coffee is reached.

BREWING ESPRESSO AND COFFEE

Before brewing coffee, make sure that there are no warnings shown on the control panel, and that the water tank and coffee bean hopper are filled. The "☕", "☕", "☕" and "☕" buttons are shining steadily.

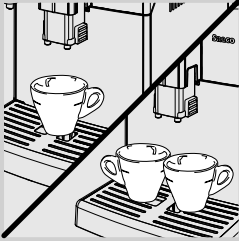

- 1 Place 1 or 2 cups under the coffee dispensing spout.

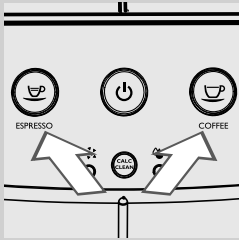

- 2 Press the "☕" button for an espresso or the "☕" button for a coffee.

- 3 To brew 1 cup of espresso or coffee, press the desired button once. The pressed button flashes slowly.

- 4 To brew 2 cups of espresso or coffee, press the desired button twice consecutively. The pressed button flashes quickly twice.

Note:

In this operating mode, the machine automatically grinds and doses the correct amount of coffee. Brewing two cups of espresso or long coffee requires two grinding and brewing cycles, automatically carried out by the machine.

- 5 After the prebrewing cycle, coffee begins to pour out of the coffee dispensing spout.

- 6 Coffee brewing automatically stops when the preset level is reached; press the same button pressed previously to stop it earlier.

FROTHING MILK / BREWING CAPPUCCINO

Frothing milk

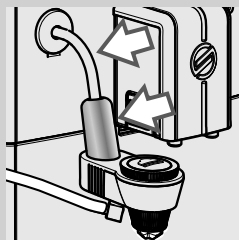

Warning:

Danger of scalding! Dispensing may be preceded by small jets of hot water. When steam is used, the steam wand and the chrome cover may reach high temperatures. Never touch them with bare hands. The Automatic Milk Frother must be handled only as shown in the figure.

- 1 Fill 1/3 of a container with cold milk.



Note:

When preparing your cappuccino, use cold (~5°C / 41°F) milk with a protein content of at least 3% to ensure optimum results. Whole milk or low-fat milk can be used depending on your personal taste.



Note:

When you plan to froth milk right after switching on the machine or after brewing a coffee, some water still present in the circuit may need to be dispensed first.

To do this, press the "☕" button to dispense steam for a few seconds. Thereafter press the "☕" button to stop dispensing. Then proceed with step 2.

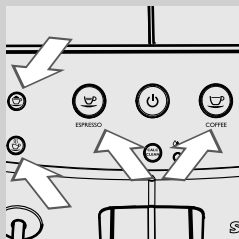

- 2 Before frothing milk, make sure that the machine is ready to use and the water tank is filled. The "☕", "☕", "☕" and "☕" buttons are shining steadily.

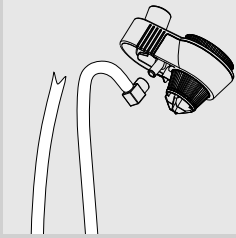

3 Insert the suction tube into the Automatic Milk Frother.

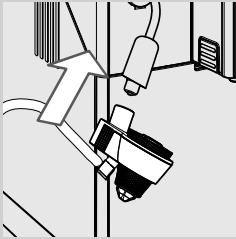

4 Insert the Automatic Milk Frother into the steam wand seat.

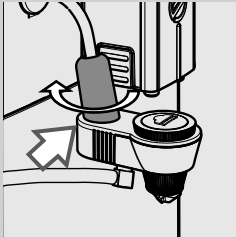

Note:

Make sure that it is positioned correctly. If you cannot insert it, rotate the chrome cover. The Automatic Milk Frother is assembled correctly when the tooth fits into the slot.

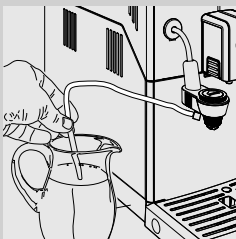
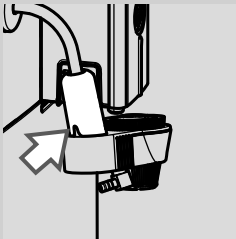

5 Insert the suction tube into the milk container.

! Caution:

Make sure that the outer surface of the suction tube is clean for hygienic reasons.

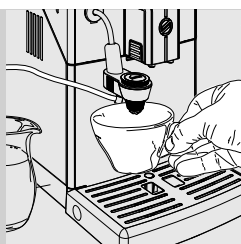

6 Place a cup under the Automatic Milk Frother.

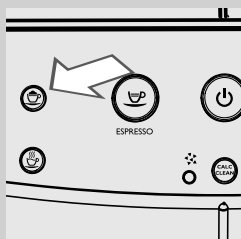

7 Press the "☕" button to froth milk. The button flashes.

8 The "☕" button flashes during the preheating time required by the machine. Once the warm-up phase has been completed, milk dispensing begins and the "☕" button flashes.

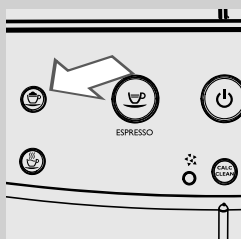

9 Press the "☕" button to stop dispensing frothed milk.



Note:

It will take a few seconds before the machine stops frothing milk completely.



Note:

Milk frothing stops after 3 minutes. If you need more, press the "☕" button again.

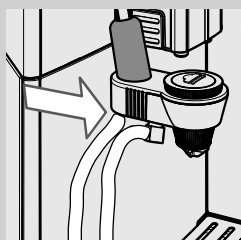

10 After use, store the suction tube as shown in the figure.

**Caution:**

After frothing milk, a small quantity of hot water must be dispensed into a container. See the "Daily Cleaning of the Automatic Milk Frother" chapter for detailed cleaning instructions.

**Note:**

It is possible to brew an espresso or dispense hot water straight after frothing milk.

Brewing a Cappuccino

To prepare a cappuccino, place a cup of frothed milk under the coffee dispensing spout and brew an espresso.

HOT WATER DISPENSING

**Warning:**

Danger of scalding! Dispensing may be preceded by small jets of hot water.

Before dispensing hot water, make sure that the machine is ready to use and the water tank is filled. The "☺", "☹", "☺" and "☺" buttons are shining steadily.

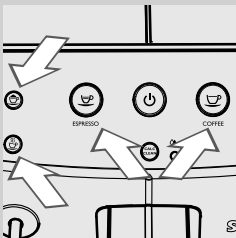

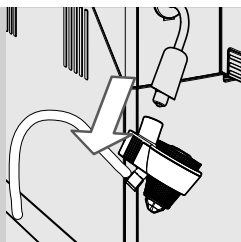



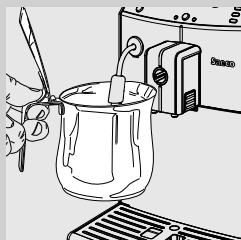

1 Remove the Automatic Milk Frother from the steam wand.

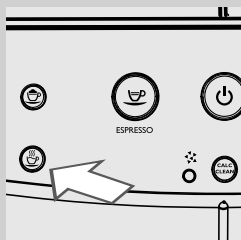



2 Place a container under the steam wand.

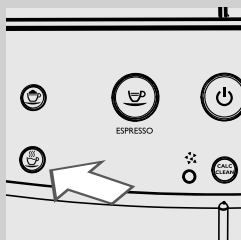

3 Press the “” button to begin dispensing hot water; the “” button flashes throughout the preparation and dispensing phase.

4 The “” button flashes during the preheating time required by the machine. Once the warm-up phase has been completed, hot water dispensing begins and the “” button flashes.



5 Pour the desired amount of hot water. To stop dispensing hot water, press the “” button.

CLEANING AND MAINTENANCE

Daily Cleaning of the Machine



Caution:

Timely cleaning and maintenance of your machine is very important as it prolongs the life of your machine. Your machine is continuously exposed to moisture, coffee and limescale!

The activities you need to perform and their frequency are described in detail in this chapter. Not doing this will ultimately make your machine stop working properly. This repair is NOT covered by your warranty.



Note:

- Use a soft, dampened cloth to clean the machine.
- Only the cup holder grill can be washed in the dishwasher. Any other components must be washed with lukewarm water.
- Do not immerse the machine in water.
- Do not use alcohol, solvents, and/or abrasive objects to clean the machine.
- Do not dry the machine and/or its components using a microwave and/or standard oven.

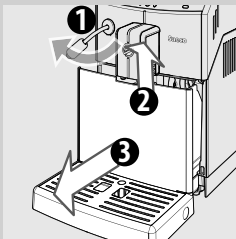

- 1** Empty and clean the coffee grounds drawer and the drip tray daily with the machine turned on.

Other maintenance operations can only be carried out when the machine is turned off and unplugged.

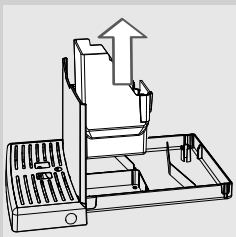

- 2** Remove the coffee grounds drawer and empty it.
- 3** Empty and clean the drip tray.

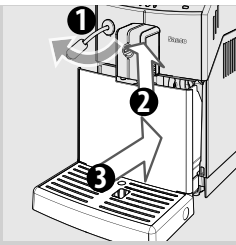

- 4 Insert the coffee grounds drawer back into the drip tray and place the drip tray back into the machine.

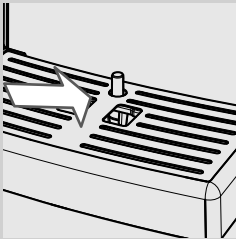

Note:

Empty and wash the drip tray also when the full drip tray indicator is raised.

Daily Cleaning of the Water Tank

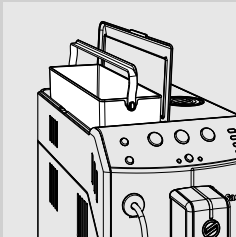

- 1 Remove the small white filter or the "INTENZA+" water filter (if installed) from the water tank and wash it with fresh water.
- 2 Put the small white filter or the "INTENZA+" water filter (if installed) back in its housing by gently pressing and turning it at the same time.
- 3 Fill the water tank with fresh water.

Daily Cleaning of the Automatic Milk Frother

For hygienic reasons and to ensure a perfect milk froth consistency, it is important that you clean the Automatic Milk Frother after each use.



Warning:

Danger of scalding! Dispensing may be preceded by small jets of hot water.

After each milk frothing, you always need to:

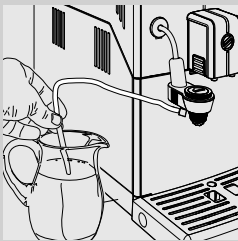

- 1 Insert the suction tube into a container filled with fresh water.

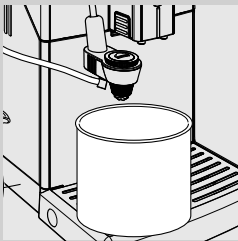

- 2 Place an empty container under the Automatic Milk Frother.

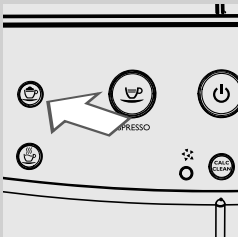

- 3 Press the "☕" button to select steam. The button flashes.
- 4 The "☕" button flashes during the preheating time required by the machine.
- 5 During the dispensing phase the "☕" button flashes. Dispense water from the Automatic Milk Frother until clear water flows out. Press the "☕" button to stop dispensing.
- 6 Clean the suction tube with a damp cloth.

Weekly Cleaning of the Machine

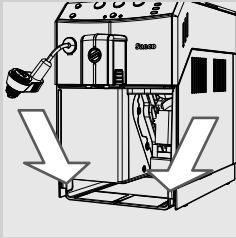

- 1 Clean the seat of the drip tray.

Weekly Cleaning of the Brew Group

The brew group should be cleaned every time the coffee bean hopper is filled or at least once a week.



- 1 Turn off the machine by pressing the “” button and unplug the power cord.

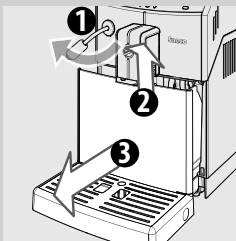

- 2 Remove the drip tray and coffee grounds drawer.

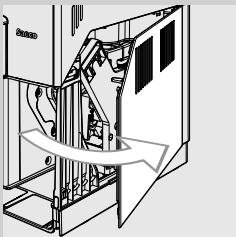

- 3 Open the service door.

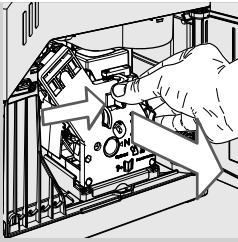

4 To remove the brew group, press the «PUSH» button and pull it by the handle. Pull it out horizontally without turning it.

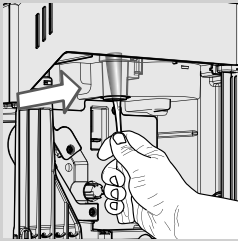

5 Clean the coffee outlet duct thoroughly with a spoon handle or with another round-tipped kitchen utensil.

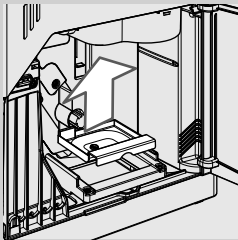

6 Remove the coffee residues drawer and wash it thoroughly.

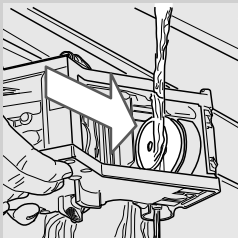

7 Thoroughly wash the brew group with fresh, lukewarm water and carefully clean the upper filter.

! **Caution:**

Do not use detergent or soap to clean the brew group.

8 Let the brew group air-dry thoroughly.

9 Thoroughly clean the inside of the machine using a soft, dampened cloth.

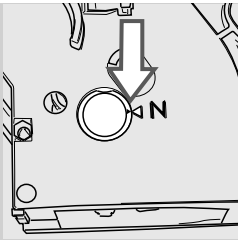

10 Make sure that the brew group is in the off position; the two reference marks must match. If they do not match, proceed as described in step (11).

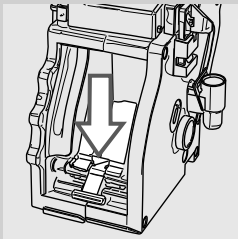

11 Gently pull down the lever until it is in contact with the brew group base and the two reference marks on the side of the brew group match.

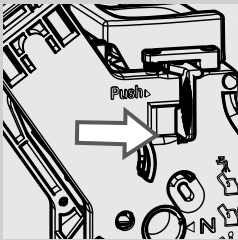

12 Press the "PUSH" button firmly.

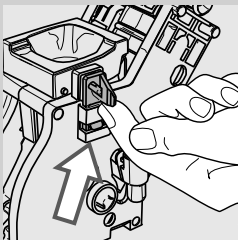

13 Make sure that the hook which locks the brew group is in the correct position. If it is still in the downward position push it upward until it locks correctly into place.

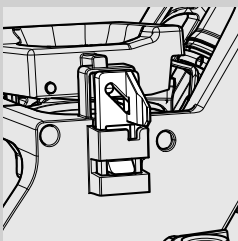

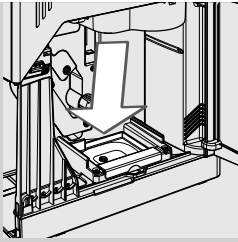

- 14** Insert the coffee residues drawer in its seat and ensure that it is correctly in place.

 **Note:**

If the coffee residues drawer is not correctly positioned, the brew group may not fit into the machine.

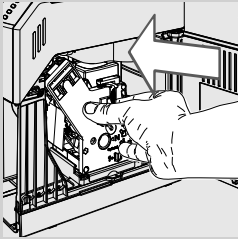

- 15** Insert the brew group back into its seat until it locks into place without pressing the "PUSH" button.

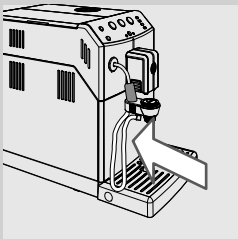

- 16** Insert the coffee grounds drawer with the drip tray back into the machine and close the service door.

Monthly Cleaning of the Automatic Milk Frother



Every month you need to perform a more thorough cleaning of the Automatic Milk Frother using the "Saeco Milk Circuit Cleaner". The "Saeco Milk Circuit Cleaner" can be purchased separately. For further details, please refer to the maintenance products page in this user manual.



Warning:

Danger of scalding! Dispensing may be preceded by small jets of hot water.

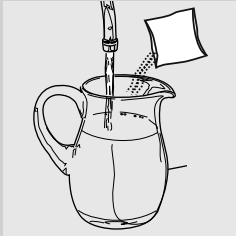

1 Make sure that the Automatic Milk Frother is correctly installed.

2 Pour the milk circuit cleaner into a container. Add ½ litre of lukewarm water and wait for the product to dissolve completely.

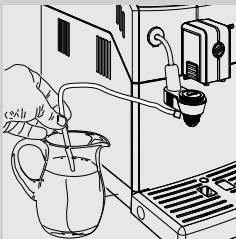

3 Insert the suction tube into the container.

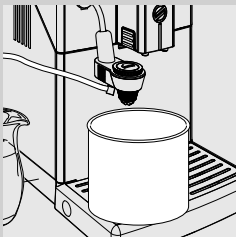

4 Place a large container (1.5 l) under the Automatic Milk Frother.

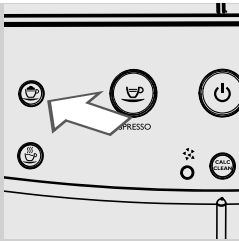

5 Press the "☕" button to dispense steam.

6 The "☕" button flashes during the preheating time required by the machine.

7 During the dispensing phase the "☕" button flashes. When the solution has been completely dispensed, press the "☕" button to stop dispensing.



Warning:
Never drink the solution dispensed during this step.

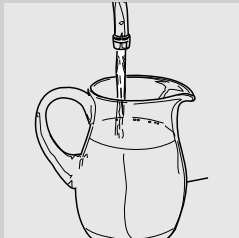

8 Rinse the container thoroughly and fill it with ½ litre of fresh water to be used for the rinse cycle.

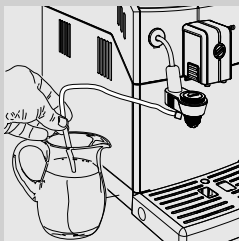

9 Insert the suction tube into the container.

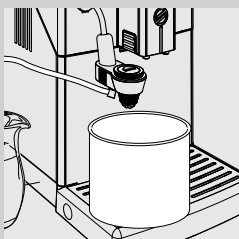

10 Empty the container and place it back under the Automatic Milk Frother.

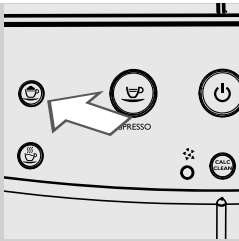

11 Press the "☕" button to dispense steam.

12 The "☕" button flashes during the preheating time required by the machine.

13 During the dispensing phase the "☕" button flashes. When the water has been completely dispensed, press the "☕" button to stop dispensing.

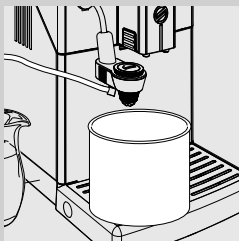

14 Empty the container.

! **Caution:**
Let the steamwand cool down for a few minutes.

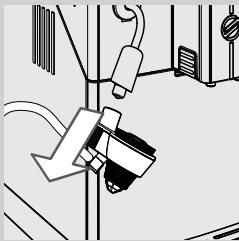

15 Remove the Automatic Milk Frother from the steam wand.

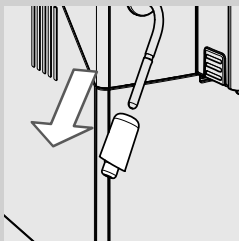

16 Remove the chrome cover with the rubber fitting from the steam wand.

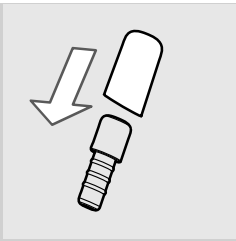

17 Remove the rubber fitting from the chrome cover.

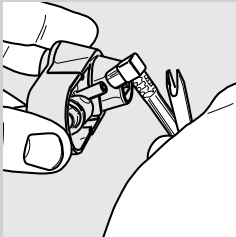

18 Remove the suction tube.

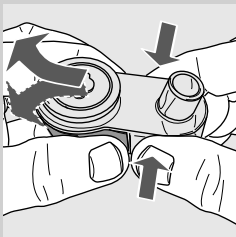

19 Press the sides and disassemble the Automatic Milk Frother as shown in the figure.

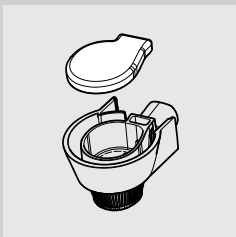

20 Remove the rubber lid as shown in the figure.

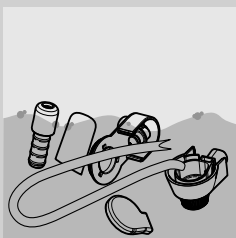

21 Wash all the components with lukewarm water.

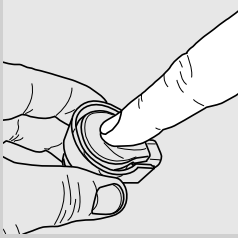

22 Reassemble the lid making sure that you press it in the middle to have it correctly inserted.

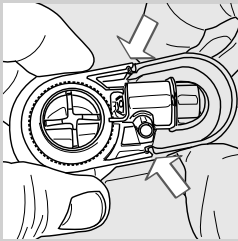

23 Reassemble the Automatic Milk Frother making sure it is correctly inserted.

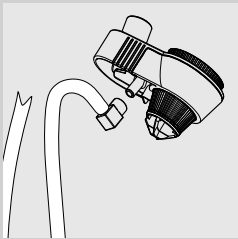

24 Install the suction tube.

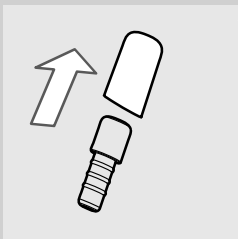

25 Insert the rubber fitting on the chrome cover.

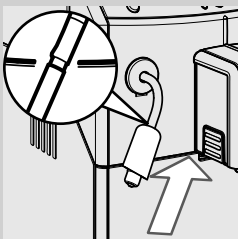

26 Reinsert them back onto the steam wand.



Warning:

The tube could be hot if the machine has recently been used. Do not insert the rubber fitting beyond the position shown. In this case, the Automatic Milk Frother would not function correctly as it would not be able to draw up milk.

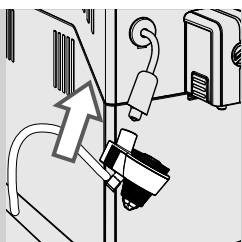

27 Insert the Automatic Milk Frother in the rubber fitting.

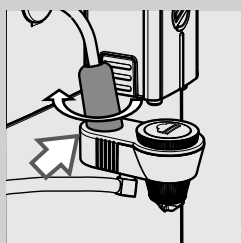

28 Make sure that it is positioned correctly. If you cannot insert it, rotate the chrome cover.
The Automatic Milk Frother is assembled correctly when the tooth fits into the slot.

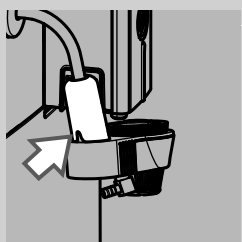

Monthly Lubrication of the Brew Group



Lubricate the brew group after approximately 500 cups of coffee or once a month.

The grease to lubricate the brew group can be purchased separately. For further details, please refer to the maintenance products page in this user manual.



Caution:

Before lubricating the brew group, clean it with fresh water and let it dry, as described in the “Weekly Cleaning of the Brew Group” chapter.

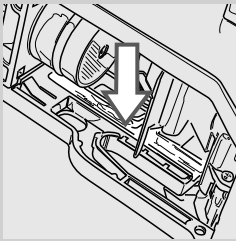

1 Apply the grease evenly on both side guides.

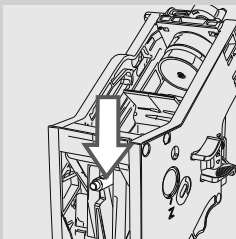
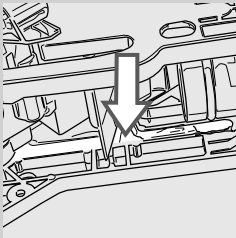

2 Also lubricate the shaft.

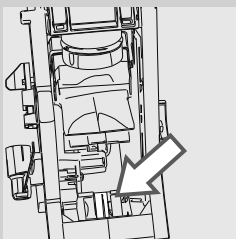

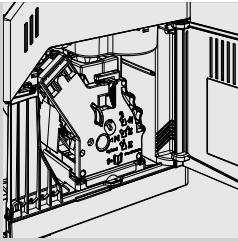

- 3 Insert the brew group into its seat until it locks into place (see the “Weekly Cleaning of the Brew Group” chapter).
- 4 Insert the coffee grounds drawer into the drip tray, then insert both back into the machine and close the service door.

Monthly Cleaning of the Coffee Bean Hopper

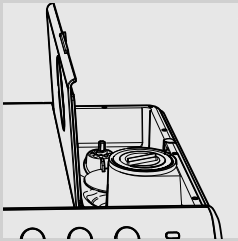

Clean the coffee bean hopper once a month when it is empty with a damp cloth to remove coffee oil. Thereafter refill it with coffee beans.

DESCALING

When the "CALC CLEAN" button shines steadily, you need to descale the machine.

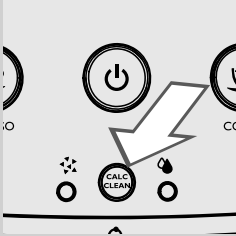

The descaling cycle takes approx. 30 minutes.



Caution:
Not doing this will ultimately make your machine stop working properly. In this case, repair is NOT covered by warranty.



Warning:
Use the Saeco descaling solution only. Its formula has been designed to ensure better machine performance. The use of other products may damage the machine and leave residues in the water.

The Saeco descaling solution can be purchased separately. For further details, please refer to the maintenance products page in this user manual.



Warning:
Never drink the descaling solution or any products dispensed until the cycle has been carried out to the end. Never use vinegar as a descaling solution.



Note:
 Do not remove the brew group during the descaling process.

To perform the descaling cycle, follow the steps below:

Before descaling:

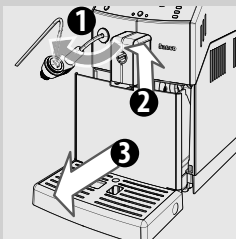

1 Empty the drip tray and the coffee grounds drawer.

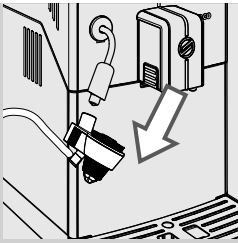

2 Remove the Automatic Milk Frother from the steam/hot water wand.

3 Remove the water tank and the "INTENZA+" water filter from the water tank (if it was installed), replacing it with the small white original one.

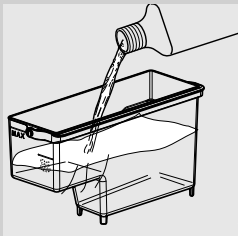

4 Pour all the descaling solution into the water tank.

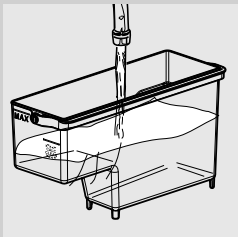

5 Fill the water tank with fresh water up to the **CALC CLEAN** level and put it back into the machine.

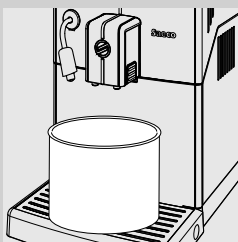

6 Place a large container (1.5 l) under both the steam/hot water wand and the coffee dispensing spout.



7 Press and hold the "**CALC CLEAN**" button for at least 3 seconds to start the descaling cycle. The "☕" button shines steadily. The "**CALC CLEAN**" button flashes throughout the cycle.

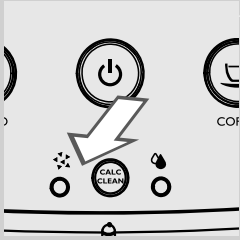

8 The "⚡" light shines steadily. The machine will start dispensing the descaling solution at regular intervals for approximately 20 minutes.

Note:

The descaling cycle may be paused by pressing the "☕" button. This allows you to empty the container or to leave the machine unattended for a short time.

To resume the cycle, press the "☕" button again. During the pause the "☕" button flashes. During the descaling cycle the "☕" button is constantly on.



9 When the "⚡" light shines steadily, the water tank is empty.

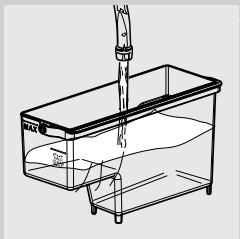

10 Rinse the water tank and fill it with fresh water up to the MAX level. Put it back into the machine.

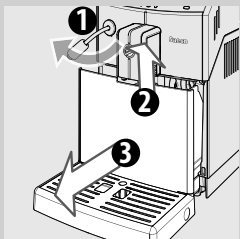

11 Empty the drip tray and place it back.

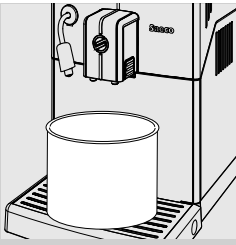

12 Empty the container and place it back.

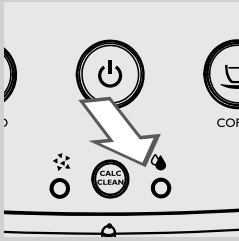

13 The "☹️" light shines steadily. When the "☕️" button flashes, press it to start the rinse cycle.

Note:

The rinse cycle may be paused by pressing the "☕️" button. This allows you to empty the container or to leave the machine unattended for a short time.

To resume the cycle, press the "☕️" button again. During the pause the "☕️" button flashes. During the descaling cycle the "☕️" button is constantly on.

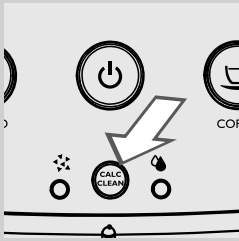

14 At the end of the rinse cycle, the "CALC. CLEAN" button turns off.

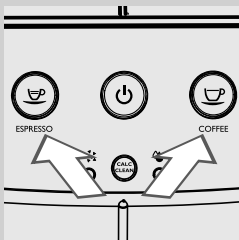

15 The machine warms up and performs the automatic rinse cycle. The "☕️" and "☕️" buttons flash simultaneously. The descaling cycle is now complete.

! Caution:

If the "☹️" red light turns on and the "☹️" light does not turn off, the water tank has not been filled to the MAX level for the rinse cycle. Fill the water tank with fresh water and repeat the process from step 13.

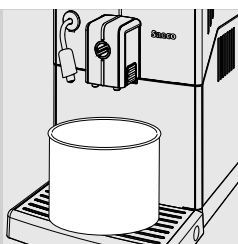

16 Empty the container used.

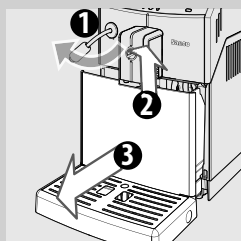

17 Empty the drip tray and place it back.

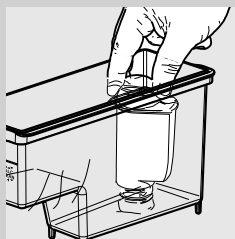

18 Remove the small white filter and place back the "INTENZA+" water filter into the water tank if it was installed.

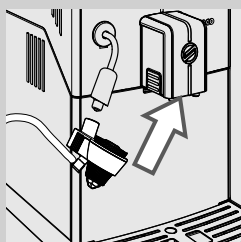

19 Put back the Automatic Milk Frother.

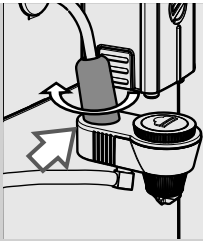

- 20** Make sure that it is positioned correctly. If you cannot insert it, rotate the chrome cover.
The Automatic Milk Frother is assembled correctly when the tooth fits into the slot.

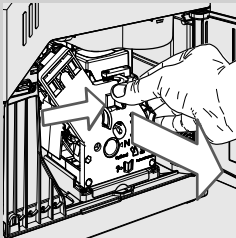
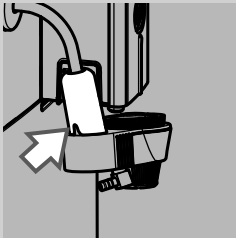

- 21** Clean the brew group. For more details, please see the “Brew Group Cleaning” chapter.

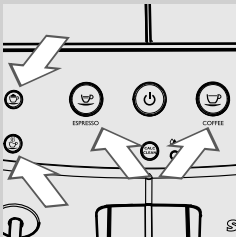

- 22** The machine is ready for use.
The "☕", "☕", "☕" and ☕ buttons are shining steadily.

INTERRUPTION OF THE DESCALING CYCLE

Once you have started the descaling cycle, you must complete it till the very end without turning off the machine.
In case you get stuck during the descaling procedure, you can exit by unplugging the power cord. If that happens follow the steps below.

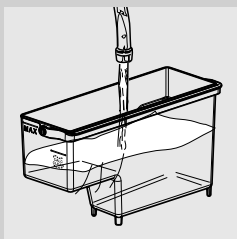

- 1 Empty and carefully rinse the water tank, then fill it with fresh water up to the MAX level.

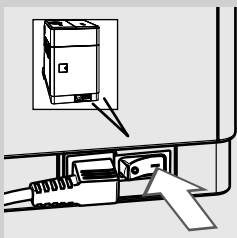

- 2 Make sure that the power button is on "I".

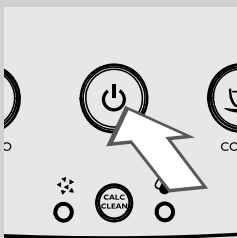

- 3 Press the "⏻" button to turn on the machine.

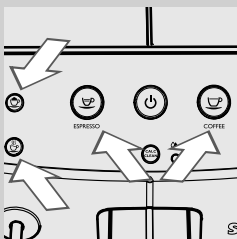

- 4 Wait until the "☕", "☕", "☕" and "☕" buttons are shining steadily.

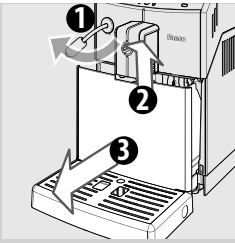

5 Empty the drip tray and place it back.

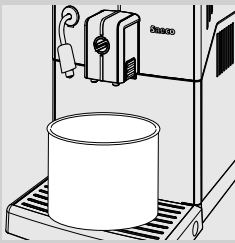

6 Empty the container and place it back.



7 Press the "☕" button to dispense 500 ml of water. The "☕" button flashes.



8 To stop dispensing water, press the "☕" button. Empty the container.

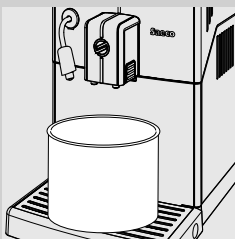

9 Place the container under the coffee dispensing spout.



10 Press the “☕” button to brew a coffee.

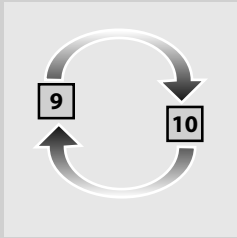

11 Repeat steps 9 – 10; then continue with step 12.

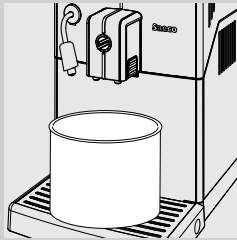

12 Empty the container. The machine is ready for use.



Note:
if the “**CALC
CLEAN**” orange light does not turn off, you still have to descale your machine at your earliest convenience.

CONTROL PANEL WARNINGS

Warning signals



Flashing

The machine is performing one of the following operations:
 - Warm-up
 - Automatic rinse.



"☕" steady on "⌵" and "⚠" flashing

The machine needs to prime the circuit. Press the "☕" button. Once pressed, the button turns off. The "⌵" and "⚠" lights flash while the circuit is being primed, and they turn off once priming has been completed.



Steady on

The machine is ready to brew coffee.



Flashing slowly

The machine is brewing one cup of espresso.



Flashing slowly

The machine is brewing one cup of coffee.



Quick double flashing

The machine is brewing two cups of espresso.

Warning signals

7

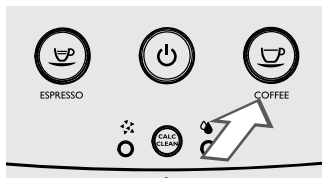

The machine is brewing two cups of coffee.

Quick double flashing

8

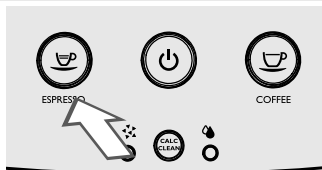

The machine is programming the amount of espresso to be brewed.

Flashing quickly

9

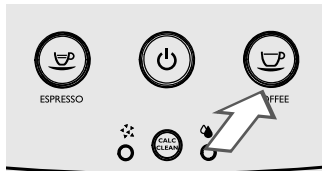

The machine is programming the amount of coffee to be brewed.

Flashing quickly

10



The machine is in the steam dispensing phase

Flashing slowly

11



The machine is in the hot water dispensing phase.

Flashing slowly

12

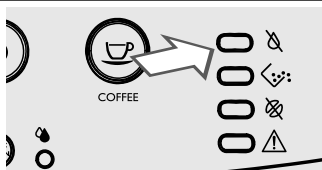

Fill the water tank.

Steady on

Warning signals

13

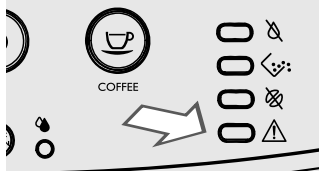

Steady on

Completely insert the drip tray with the coffee grounds drawer into the machine and close the service door.

14



Flashing quickly

The brew group is being reset due to machine reset.

15



Flashing slowly

Insert the brew group.

16



Steady on

Empty the coffee grounds drawer.

17

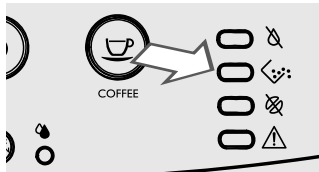

Flashing

The coffee grounds drawer is not inserted into the machine. Wait a few seconds until the "<img alt='coffee grounds drawer icon' data-bbox='348 545 378 565' style='vertical-align: middle;'" data-bbox="348 545 378 565" light turns off and the "<img alt='warning triangle icon' data-bbox='348 605 378 625' style='vertical-align: middle;'" data-bbox="348 605 378 625" light shines steadily. Then insert the coffee grounds drawer and close the service door.

18

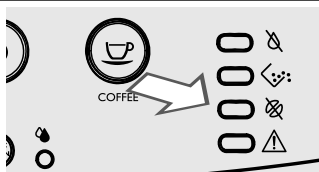

Steady on

Fill the coffee bean hopper with coffee beans and restart the brewing cycle. The light turns off when the brew button of the selected product is pressed.

It is possible to dispense steam and hot water when this warning message appears.

Warning signals

19

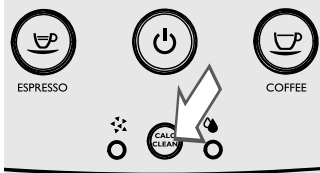

Steady on

You need to descale the machine. Follow the steps described in the “Descaling” chapter of this manual.

Please note that not descaling your machine will ultimately make it stop working properly. In this case repair is NOT covered under your warranty.

20



All lights flashing simultaneously

Your machine is out of order.

Turn off the machine. Turn it back on after 30 seconds.

Repeat the procedure 2 or 3 times.

If the machine does not start, contact the Philips SAECO hotline in your country (contact details in the warranty booklet)

TROUBLESHOOTING

This chapter summarizes the most common problems you could encounter with your machine.

If you are unable to solve the problem with the information below, visit www.saeco.com/support for a list of frequently asked questions or contact the Philips Saeco hotline in your country.

Contact details can be found in the warranty booklet packed separately or at www.saeco.com/support.

Machine actions	Causes	Solutions
The machine does not turn on.	The machine is not connected to the electric network, or the power button is in the "O" position.	Connect the machine to the electric network and turn the power button to the "I" position.
The drip tray gets filled although no water is drained.	Water is sometimes drained automatically by the machine into the drip tray to manage the rinsing of the circuits and ensure optimum machine performance.	This is a normal behaviour of the machine.
The "☕" light is always displayed on the machine.	The coffee grounds drawer has been emptied with the machine off.	The coffee grounds drawer must always be emptied with the machine on.
Coffee is not hot enough.	The cups are cold.	Preheat the cups with hot water.
Coffee does not have enough crema (see note)*.	The blend is unsuitable, coffee is not freshly roasted or the grind is too coarse.	Change coffee blend or adjust the grind setting as explained in the "Adjusting the Coffee Grinder" chapter.
The machine takes a long time to warm up or the amount of water dispensed is too little.	The machine circuit is clogged by limescale.	Descale the machine.
The brew group cannot be removed.	The brew group is out of place.	Turn on the machine. Close the service door. The brew group automatically returns to the initial position.
	The coffee grounds drawer is inserted.	Remove the coffee grounds drawer before removing the brew group.
The brew group cannot be inserted.	The brew group is not in the off position.	Make sure that the brew group is in the off position, as described in the "Weekly Cleaning of the Brew Group" chapter.
	The gearmotor is not in the correct position.	Insert the drip tray and the coffee grounds drawer. Close the service door. Turn on the machine without inserting the brew group. The gearmotor moves back to the correct position. Turn off the machine and reinsert the brew group as described in the "Weekly Cleaning of the Brew Group" chapter.

Machine actions	Causes	Solutions
The machine grinds the coffee beans but no coffee is brewed (see note)*.	The brew group is dirty.	Clean the brew group (see the "Weekly Cleaning of the Brew Group" chapter).
	This might occur when the machine is automatically adjusting the dose.	Brew a few cups of coffee as described in the "Saeco Adapting System" chapter.
	The coffee dispensing spout is dirty.	Clean the coffee dispensing spout.
The coffee is too weak (see note)*.	This might occur when the machine is automatically adjusting the dose.	Brew a few cups of coffee as described in the "Saeco Adapting System" chapter.
	The ceramic coffee grinder is set to a coarse grind.	Adjust the ceramic coffee grinder to a finer setting (see the "Adjusting the Ceramic Coffee Grinder" section).
Coffee is brewed slowly (see note)*.	The coffee grind is too fine.	Change coffee blend or adjust the grind as explained in the "Adjusting the Coffee Grinder" chapter.
	The brew group is dirty.	Clean the brew group (see the "Weekly Cleaning of the Brew Group" chapter).
Coffee leaks out of the coffee dispensing spout.	The coffee dispensing spout is clogged.	Clean the coffee dispensing spout and its holes.
No hot water or steam is dispensed.	The hole of the steam/hot water wand is clogged.	Clean the hole of the steam wand using a pin. Make sure that the machine is off and has cooled down before performing this operation.
The descaling cycle cannot be finished.	Most probably you have used not enough water for rinsing.	Unplug the power cord and follow the instructions described in the sector "Interruption of the descaling cycle".

**Note:**

(*) These problems can be considered normal if the coffee blend has been changed or if the machine has just been installed. In this case, wait until the machine performs a self-adjusting operation as described in the "Saeco Adapting System" chapter.

ENERGY SAVING

Stand-by



The Saeco fully automatic espresso coffee machine is designed for energy saving, as proven by the Class A energy label.

After 30 minutes of inactivity, the machine turns off automatically. If a product has been brewed, the machine performs a rinse cycle.

In stand-by mode, the energy consumption is below 1Wh.
To turn on the machine, check that the power button on the back of the machine is set to "I".
Thereafter press the "⏻" button.
If the boiler is cold, the machine performs a rinse cycle.

TECHNICAL SPECIFICATIONS

The manufacturer reserves the right to make changes to the technical specifications of the product.

Nominal Voltage - Power Rating - Power Supply	See data plate on the inside of the service door
Housing material	Thermoplastic material
Size (w x h x d)	215 x 330 x 429 mm / 8.5" x 13" x 16.9"
Weight	7 kg / 16 pounds
Power cord length	800 - 1200 mm / 32-47"
Control panel	Front panel
Cup sizes	Up to 152 mm / 6"
Water tank	1.8 litres / 60.8 oz - Removable type
Coffee bean hopper capacity	250 g / 1 cup
Coffee grounds drawer capacity	15
Pump pressure	15 bar
Boiler	Stainless steel type
Safety devices	Thermal fuse

WARRANTY AND SERVICE

Warranty

For detailed information on your warranty and related conditions, please read the warranty booklet supplied separately.

Service

We want to ensure that you remain satisfied with your machine. If you have not already done so, please register your purchase at **www.saeco.com/welcome**. This will enable us to stay in contact with you and send you cleaning and descaling reminders.

If you need service or support, please visit the Philips website at **www.saeco.com/support** or contact the Philips Saeco hotline in your country. The contact details can be found in the warranty booklet supplied separately or at **www.saeco.com/support**.

ORDERING MAINTENANCE PRODUCTS

For cleaning and descaling, use Saeco maintenance products only. You can purchase these products at the Philips online shop (if available in your country) at www.shop.philips.com/service, from your local dealer or at authorised service centres.

If you have any difficulties obtaining maintenance products for your machine, please contact the Philips Saeco hotline in your country.

Contact details can be found in the warranty booklet packed separately or at www.saeco.com/support.

Overview of maintenance products



- Descaling solution CA6700



- INTENZA+ Water filter cartridge CA6702



- Grease HD5061



- Maintenance Kit CA 6706

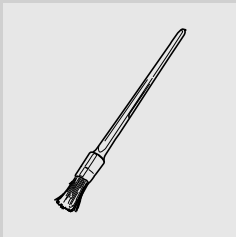

- Cleaning brush HD5084



The manufacturer reserves the right to make changes without prior notice.

www.saeco.com/welcome



421946015381

Rev.00 del 30-12-14