

Register your product and get support at
www.philips.com/welcome

HD7826, HD7824, HD7820



PHILIPS

IMPORTANT SAFEGUARDS

When using electrical appliances, basic safety precautions should always be followed including the following:

Read all instructions before using the appliance.

1. Do not touch hot surfaces. Use handles or knobs. Care must be taken to prevent burns which can occur from touching hot parts or spilling hot liquids.
2. To protect against fire, electrical shock and injury to persons, do not immerse cord, plug, or appliance in water or other liquid.
3. Close supervision is necessary when any appliance is used by or near children.
4. Unplug from outlet when not in use and before cleaning. Allow to cool before putting on or taking off parts and before cleaning appliance.
5. Do not operate this appliance with a damaged cord or plug, or after the appliance malfunctions or has been damaged in any manner. Return the Coffee Machine to the Philips Norelco Service Location for examination, repair or adjustment.
6. Use this appliance only for its intended purpose as described in this manual. Do not use accessory attachments not recommended by Philips Electronics North America Corporation as they may result in fire, electric shock or injury to persons.
7. Do not use outdoors.
8. Do not let cord hang over edge of table or counter or touch hot surfaces. Operate on a flat, stable surface away from edge of counter to prevent accidental tipping.
9. Do not place Coffee Machine on or near a hot gas or electric burner; or in a microwave or heated oven.
10. This appliance is intended for household use ONLY; it is not for commercial or industrial use.
11. Any service to the Coffee Machine should be performed by the Philips Norelco Service Location.
12. To disconnect Coffee Machine, press power button **⏻** to 'OFF', then remove plug from electrical outlet. Remove plug by gripping plug body and pulling it from the outlet. Never yank or twist cord to unplug.
13. Do not use Coffee Machine if lid has a cracked, loose, weakened or damaged lever.
14. This appliance does not work at temperatures below 50°F/10°C.
15. Do not use this appliance at altitudes higher than 6800 ft. / 2200 m above sea level.
16. Flush the Coffee Machine with fresh water before using it for the first time (See 'Preparing the machine for use'). This will cause the boiler to fill with water; which is essential for the machine to work properly.

17. To prevent scalds and/or property damage, always make sure Coffee Machine lid is securely in place and properly locked before you start using the machine and during brew cycle. Do not force when opening or closing lid.
18. Do not open lid until Coffee Machine has finished brew cycle. Hot steam or hot water trapped under lid cover could burn your fingers.
- 19. Warning: To reduce the risk of fire or electric shock, do not remove the bottom cover. No user serviceable parts are inside. Return the Coffee Machine to the Philips Norelco Service Location for examination, repair or adjustment.**

SAVE THESE INSTRUCTIONS

SPECIAL INSTRUCTIONS

This Coffee Machine has a short cord to reduce the hazards of becoming entangled in or tripping over a longer cord. An extension cord may be used if the rating is equal to or greater than the rating of the Coffee Machine. Use an extension cord rated 13 amperes or greater. Care must be taken to arrange extension cord so that it does not hang over the edge of counter top or table top, where it can be pulled on by children or tripped over unintentionally. Operating the Coffee Machine and another appliance at the same time from the same electrical circuit could cause an electrical overload, which would blow the fuse or trip the circuit breaker.

SPECIAL POLARIZED PLUG INSTRUCTIONS

This Philips Coffee Machine has a polarized plug (one blade is wider than the other) as an added safety feature. To reduce the risk of electric shock:

- Plug will fit into polarized outlet only one way.
- If plug does not properly fit into outlet at first, reverse it.
- If plug still does not fit, contact a qualified electrician.

DO NOT ATTEMPT TO DEFEAT THIS SAFETY FEATURE IN ANY WAY.

WARNING:

- To avoid risk of personal injury or damage to property as a result of overflow, be sure that the cup or mug is centered under the coffee outflow unit during the brew cycle.
- Brewed coffee and coffee pods are very hot. Handle with care to avoid scalding.
- If coffee spout overflows or fails to drain into cup/mug during brewing cycle, do not open lid or handle coffee spout or coffee pod holder(s). Unplug Coffee Machine and wait for contents to cool before handling.
- Do not remove any part of Coffee Machine or cup/mug during the brew cycle as scalding could occur.
- Use only fresh, cool water in this appliance. Do not put any other liquids in this appliance except as instructed in the 'Descaling' section. Do not refill the water reservoir with hot water or coffee.
- DO NOT attempt to move an appliance containing hot liquids or during the brewing process. Allow appliance to cool completely before moving.
- Keep appliance at least 4 inches away from walls or other objects while operating. Do not place any object on top of coffee machine while operating.
- It is very important that you descale your SENSEO® machine every 3 months to prevent malfunctioning. For the correct procedure, see chapter 'Descaling'.
- **Never interrupt the descaling process!**
- Always use the correct descaling mixture, i.e. 50 grams citric acid to 1 litre tap water.
-  Never turn your SENSEO® machine on its side. Always keep it in upright position, also during transport.

**PLEASE READ AND SAVE THIS
INSTRUCTION BOOKLET.**

TABLE OF CONTENTS

General description	6
Introduction	7
Preparing the machine for use	7
Brewing coffee	9
Cleaning	12
Descaling	15
Storage	16
Assistance	16
Troubleshooting	16
Warranty	19

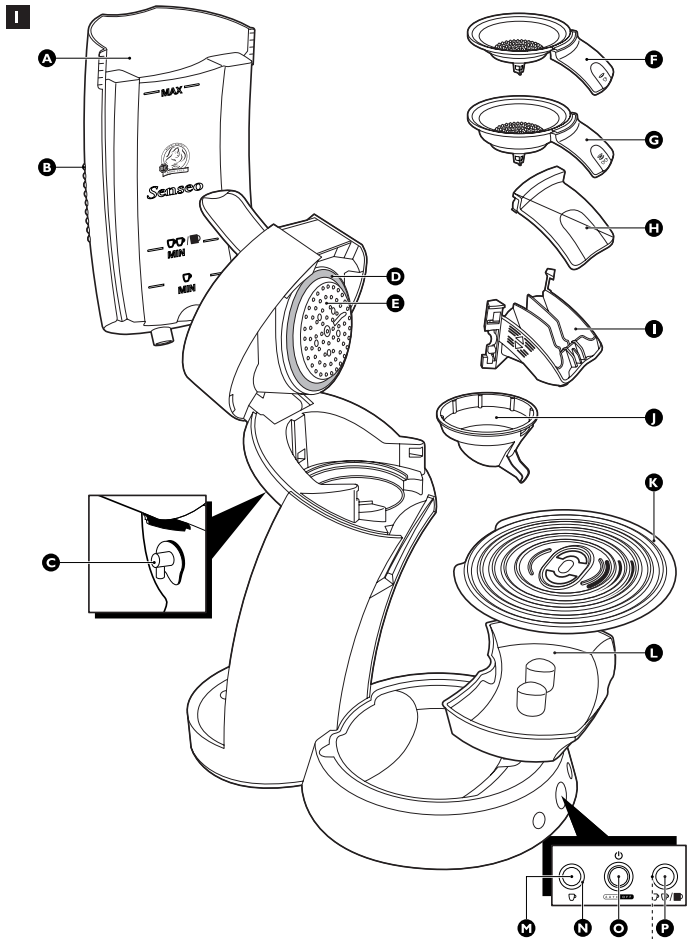

General description (Fig. 1)

- A** Water reservoir
- B** Grip area
- C** Outflow valve
- D** Sealing ring
- E** Water distribution disc
- F** 1-cup pod holder ☐
- G** 2-cup pod holder ☐☐
- H** Cover of coffee spout
- I** Coffee spout
- J** Coffee collector
- K** Cup tray
- L** Drip tray
- M** 1-cup button ☐
- N** Water level light rings (HD7826, HD7824 only)
- O** On/off button with indicator light
- P** 2-cup button ☐☐/■

Introduction

With Douwe Egberts SENSEO® coffee pods, you can enjoy a perfect cup of coffee at any time of the day. Every cup is freshly brewed to give you that smooth and full taste.

Using more than 250 years of coffee expertise Douwe Egberts has roasted and ground specially selected coffee beans that, when prepared using a special brewing method co-developed with Philips, ensure a full, smooth taste and delicious foam layer. This joint creation, known as the SENSEO® coffee pod system, consists of the Philips SENSEO® coffee machine and specially developed Douwe Egberts SENSEO® coffee pods. Only when used together will you be rewarded with a sensational cup of SENSEO® coffee with the delicious SENSEO® foam layer.

To ensure a smooth and full coffee taste, you should keep the following things in mind:

Fresh water

Use fresh water every day. If you have not used the coffee machine for three days, you have to flush it with fresh water before you use it again (see section 'Flushing' in chapter 'Cleaning').

Fresh coffee pods

Use the SENSEO® coffee pods that have been specially developed by Douwe Egberts for your SENSEO® coffee machine for a full, round taste. The Douwe Egberts SENSEO® coffee pods will stay fresh longer if you store them in an airtight storage container.

A clean machine

Clean and descale your Philips SENSEO® coffee machine regularly (see chapters 'Cleaning' and 'Descaling'). Remove used coffee pods after brewing. If a used pod has been left in the coffee machine and you have not used the machine for some time, flush the machine before you use it again (see section 'Flushing' in chapter 'Cleaning').

Preparing the machine for use

USE THIS SENSEO® COFFEE MACHINE FOR ITS INTENDED HOUSEHOLD USE AS DESCRIBED IN THIS MANUAL. YOU CANNOT BREW COFFEE IF YOU HAVE NOT FLUSHED THE SENSEO® COFFEE MACHINE FIRST!

The flushing cycle causes the boiler to be filled with water. After this the coffee machine is ready for use.

Flush the machine in the following way:

- 1** Remove the water reservoir.

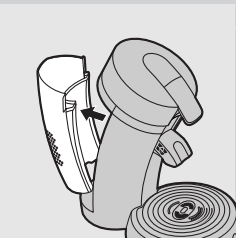

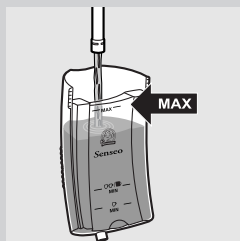

- 2** Fill the water reservoir with cold water up to the **MAX** indication and put it back onto the machine.

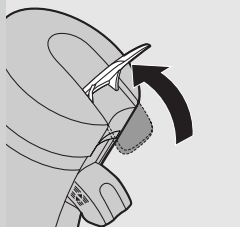

- 3** Release the lid by moving the lever upwards.

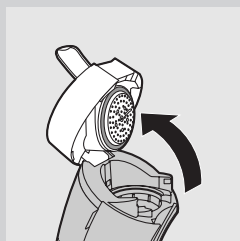

- 4** Open the lid.

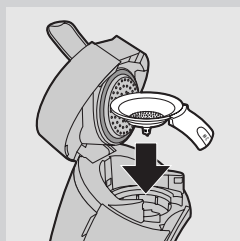

- 5** Put the 1-cup pod holder ☐ or the 2-cup pod holder ☐☐ in the machine without pod(s).

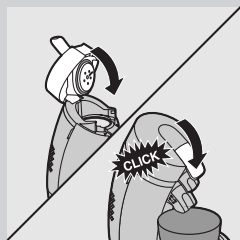

- 6** Close the lid and lock the lever.

Note: Make sure the lever is properly locked by pushing it down until it snaps home with a click.

Note: Never flush the machine with the lid open. The lid must be properly locked.

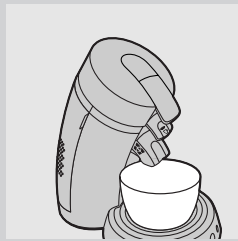

- 7** Put the plug into a grounded 120V AC electrical outlet.



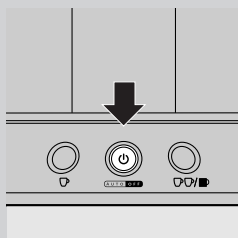

- 8** Put a bowl (with a capacity of at least 1.6 qt./ 1.5 litres) under the spout openings to collect the water.

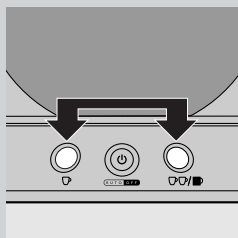

- 9** Press the on/off button .

Type HD7826/HD7824 only: after pressing the on/off button, the light rings around the 1-cup button  and the 2-cup button  burn continuously.



- 10** Press the 1-cup button  AND the 2-cup button  briefly at the same time.

The boiler fills itself with water from the water reservoir. This may take some time (approx. 90 to 150 seconds). The machine switches off automatically when the flushing cycle ends. During the flushing cycle the machine produces more noise than during a regular brewing cycle.

Never interrupt the flushing cycle halfway. If you do, the boiler will not fill itself properly.

Note: Before you use the machine for the first time, clean the coffee spout, the coffee collector and the pod holders with hot water and some dish soap or in the dishwasher. Clean the water reservoir thoroughly in hot water, if necessary with some dish soap.

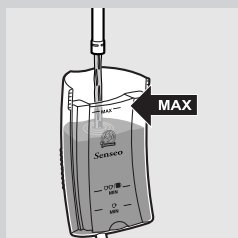

Now your Philips SENSEO® coffee machine is ready for use.

Brewing coffee



- 1** Fill the water reservoir with cold water up to the **MAX** indication and put it back onto the machine.

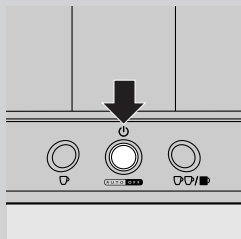

Never pour milk, coffee, hot water or carbonated water into the water reservoir.

-  MIN: minimum amount of water required to brew one 4 oz. cup of SENSEO® coffee.
-  MIN: minimum amount of water required to brew one 8 oz. mug or two 4 oz. cups of SENSEO® coffee.
- A full reservoir allows you to make up to eight 4 oz cups or four 8 oz. mugs of SENSEO® coffee. This makes it unnecessary to fill the water reservoir each time you want to make a cup of coffee.



2 Press the on/off button .

The indicator light blinks slowly while the water is heating up. Heating up takes approx. 75 seconds.

- ▶ The coffee machine is ready for use when the indicator light burns continuously. If the indicator light blinks rapidly, the water reservoir does not contain enough water for brewing one cup of coffee.
- ▶ Type HD7826/HD7824 only: the light rings around the 1-cup button  and the 2-cup button  also go on when the machine is ready for use. If there is not enough water for brewing two cups of coffee, the light ring around the 2-cup button  will not go on and this button cannot be operated.



3 Release the lid by moving the lever upwards.

4 Open the lid.

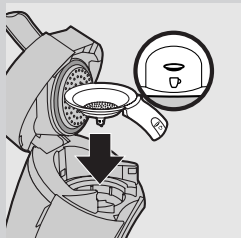
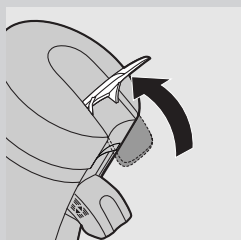

5 Place the appropriate pod holder in the machine.

Note: Make sure the pod holder is clean and the sieve in the centre is not clogged, e.g. with loose coffee grounds.

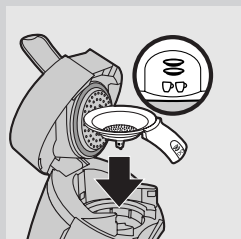

- ▶ If you want to make one cup of SENSEO® coffee, use 1 coffee pod in combination with the 1-cup pod holder  and the 1-cup button .



- ▶ If you want to make two cups of SENSEO® coffee, use 2 coffee pods in combination with the deeper 2-cup pod holder  and the 2-cup button .

6 Place the SENSEO® coffee pod(s) properly in the center of the pod holder, with the flat SENSEO® side up and the rounded side facing down.

Note: Use SENSEO® coffee pods from Douwe Egberts specially designed for your SENSEO® coffee machine for a full and round taste.

Note: Make sure the coffee in the pod(s) is evenly distributed and press the pod(s) lightly into the pod holder.

Note: Never put normal ground coffee or use torn pods in the SENSEO® machine, as this will cause it to become blocked.

- ▶ Place 1 SENSEO® coffee pod in the 1-cup pod holder ,
- or

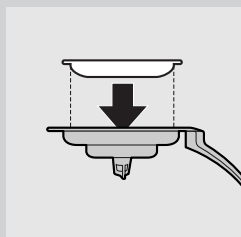

- Place 2 SENSEO® coffee pods in the 2-cup pod holder ☞☞.

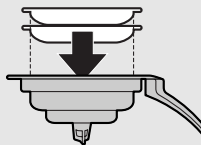

- 7** Close the lid and lock the lever.

Always check if the lid is properly locked. The lever must be pushed down until it snaps home with a click.

Never start brewing with the lid open. The lid must be properly closed.

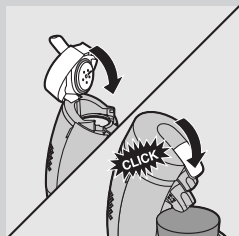

- 8** Place one cup or two cups under the spout openings. You can adjust the height of the coffee spout by sliding it upwards or downwards.

If you are using cups, make sure they have a capacity of 5 oz. If you are using a mug, make sure the mug has a capacity of 10 oz. Do not use cups that are too large, as they will cause the coffee to get cold more quickly.



- 9** Press the button indicating the number of cups of SENSEO® coffee you want to brew.

- Press the 1-cup button ☞ for one 4 oz. cup.
- Press the 2-cup button ☞☞/☞ for one 8 oz. mug or two 4 oz. cups.

Types HD7826, HD7824 only: the light rings around the 1-cup button ☞ and the 2-cup button ☞☞/☞ indicate if there is still enough water left for brewing one or two cups of coffee. If there is not enough water left in the water reservoir for brewing two cups of coffee, the light ring around the 2-cup button ☞☞/☞ will not go on and this button cannot be operated.

- The SENSEO® coffee machine starts brewing.

- The machine automatically supplies the optimal amount of water.
- You can interrupt the brewing process at any time by pressing the on/off button ☞. If you switch the machine back on after having interrupted the brewing process, the machine will not complete the interrupted brewing cycle.

Do not remove the water reservoir during a brewing cycle, as this will cause the machine to draw in air. When this happens, the next cup will only be partly filled.

Type HD7820 only: if the cups are only half full when the machine stops brewing, there was not enough water left in the water reservoir to brew

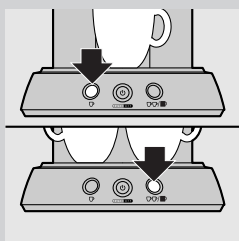

two cups. To obtain two full cups, fill the water reservoir and press the 1-cup button . The two cups will then be filled completely.

Note: If you only get a small quantity of coffee or no coffee at all out of the machine, you have not flushed the machine properly before first use. As a result, the boiler is not or not completely filled. Flush the machine properly (see chapter 'Preparing the machine for use') before you brew another cup of coffee.

10 Remove the coffee pod(s) after use by lifting the pod holder out of the machine and emptying it.

Be careful when doing this, for there may still be some hot water/coffee on the coffee pod(s) or steam may escape.

Tips

- ▶ By rinsing the pod holders, the coffee collector and the coffee spout regularly, you will make sure that the coffee always tastes optimally.
- ▶ The SENSEO® coffee will taste best if you stir it before drinking it.
- ▶ If you intend to make another cup of SENSEO® coffee later, just leave the coffee machine switched on. The machine will automatically switch itself off after 1 hour.

AUTO OFF

Cleaning

Never immerse the SENSEO® coffee machine in water or any other liquid.

Never clean the machine by flushing it with the lid open.

- 1** Always turn machine off and unplug before cleaning it.
- 2** Clean the outside of the machine with a moist cloth.
- 3** Remove the coffee collector.

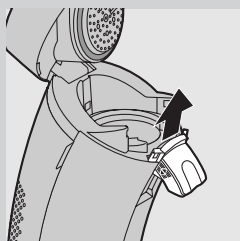
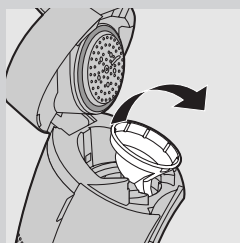

- 4** Take the coffee spout out of the machine by sliding it upwards.

The coffee spout can only be taken out after the coffee collector has been removed.

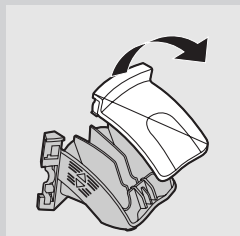

► You can disassemble the coffee spout for more thorough cleaning!

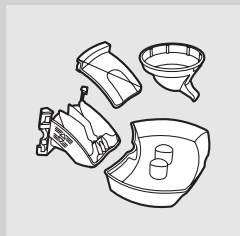

5 Clean the coffee spout, the coffee collector and the drip tray in hot water, if necessary with some dish soap, or in the dishwasher.

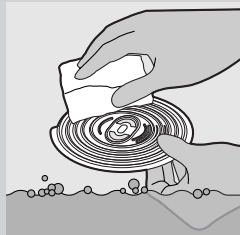

6 Hold the cup tray in your hand while cleaning it with hot water, if necessary with some dish soap.

The cup tray can also be cleaned in the dishwasher.

To clean the cup tray, always remove it from the machine, as it might prove sharp when handled incorrectly. Always handle it carefully.

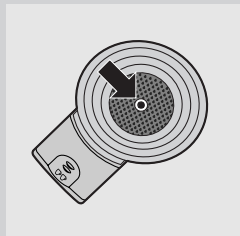

7 Clean the pod holders in hot water, if necessary with some dish soap, or in the dishwasher.

Check if the sieve in the centre of the pod holder is clogged. If this is the case, unclog the sieve by rinsing the pod holder under a running tap. Use a soft dish brush to clean the sieve, if necessary.

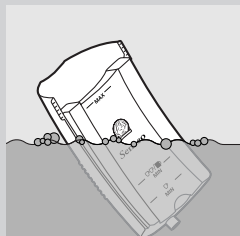

8 Clean the water reservoir in hot water, if necessary with some dish soap.

Note: If you are using a soft dish brush, be careful not to damage the valve in the bottom of the water reservoir.

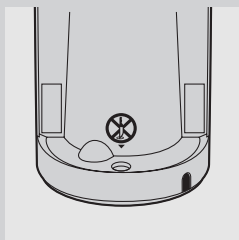

9 Do not use an object with sharp edges to clean the water inlet on the machine.

10 Rinse the parts with fresh water after cleaning and put them back into the machine.

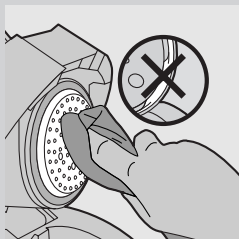

11 Clean the water distribution disc with a moist cloth.

Be careful when you do this; make sure that the rubber sealing ring does not get stuck under the edge of the water distribution disc. If it does, the coffee machine will start leaking!

Flushing

If you have not used the coffee machine for three days, you have to flush it with fresh water before you use it again.

Flush the machine in the following way:

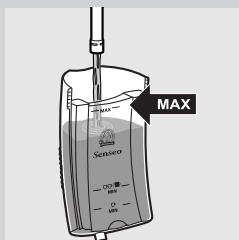

1 Fill the water reservoir with cold water up to the **MAX** indication and put it back into the machine.

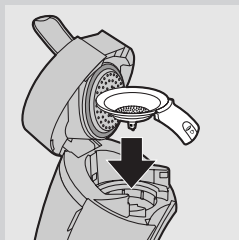

2 Put the 1-cup pod holder ☐ or the 2-cup pod holder ☐☐ in the machine without pod(s).

3 Close the lid and lock the lever.

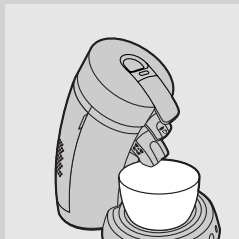

4 Put a bowl (with a capacity of at least 1.6 qt./1.5 litres) under the coffee spout to collect the water.

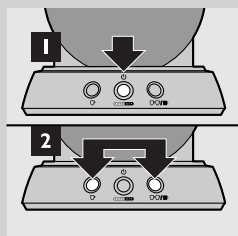

- 5** Press the on/off button ⏻ (1) and subsequently press buttons the 1-cup button ☺ and the 2-cup button ☺☺ briefly at the same time (2).

The machine fills itself with water from the water reservoir. While this happens, water comes out of the spout. When the flushing cycle is finished, the machine switches itself off. During the flushing cycle, the machine produces more noise than during a regular brewing cycle.

Never interrupt the flushing cycle halfway. If you do, the boiler will not fill itself properly. Repeat step 5 if the cycle is interrupted.

Descaling

When to descale

Descal the SENSEO® coffee machine frequently! Preferably descale 4 to 6 times a year, but at least once every 3 months. Descaling takes about 1 hour. Do not interrupt the descaling process.

Why to descale

Scale builds up inside the appliance during use. It is essential to descale the SENSEO® coffee machine at least every 3 months. Your reasons to descale:

- It prolongs the life of your SENSEO® coffee machine
- It ensures maximum cup volume
- It ensures maximum coffee temperature
- The machine produces less sound during brewing
- It prevents malfunctioning

If the descaling procedure is not performed correctly, scale residue remains behind in the machine. This causes scale to build up more quickly and may cause permanent and irreparable damage to the machine.

Use the correct descaling agent

Only citric acid-based descalers are suitable for descaling the SENSEO® machine. This type of descaler descales the appliance without damaging it. For the correct amount, see under 'Descaling procedure' below. Each descaling mixture can be used only once. After use, the descaling mixture is no longer active.

We advise you to use the special SENSEO® Descaler (HD7006). Read the instructions on the package of the descaling agent.

Never use a descaling agent based on mineral acids such as sulphuric acid, hydrochloric acid, sulphamic acid and acetic acid (e.g. vinegar). These descaling agents may damage your SENSEO® coffee machine.

Descaling procedure

- 1** Mix 50 grams of citric acid with 1 litre of water in a measuring jug. Stir until the powder is completely dissolved.

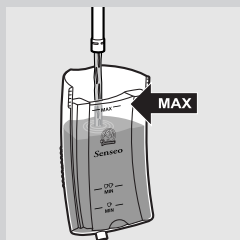

- 2** Fill the water reservoir up to the MAX indication with the descaler mixture. Then put the water reservoir back into the coffee machine.

Note: Not all SENSEO® machine types have a water reservoir with a capacity of 1 litre. If you have a SENSEO® machine with a smaller water reservoir, repeat steps 2 to 6 with the remainder of the mixture without filling the water reservoir up to the MAX indication.

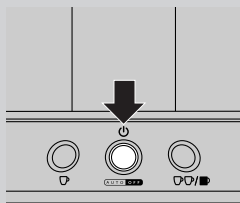

- 3** Press the on/off button .

The machine is ready for use when the indicator light burns continuously.

- 4** Place the 1-cup pod holder  with a used coffee pod in it in the coffee machine. Close the lid and make sure it is properly locked.

Note: Always put a used coffee pod in the pod holder when you descale the machine. This pod serves as a 'filter' to prevent the sieve or hole in the pod holder from getting clogged with scale residue.

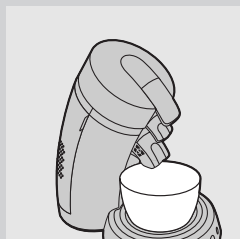

- 5** Put a bowl with a capacity of at least 1.6 qt./1.5 litres under the spout to collect the descaling mixture.

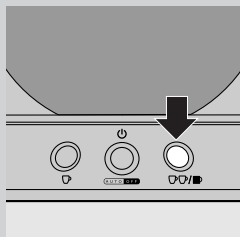

- 6** Press the 2-cup button  and let the machine operate. Repeat this until the water reservoir is empty.

⚠ Never interrupt the descaling process!

- 7** Repeat steps 1 to 6. Replace the used pod with another used pod to filter out the scale residue.

Note: To descale properly, you have to use 2 litres of descaling mixture.

⚠ Never descale the SENSEO® coffee machine with the lid open.
Make sure the lid is properly locked.

- 8** Rinse the water reservoir with tap water. Fill the water reservoir up to the MAX indication with tap water and repeat steps 3 to 6.

Note: Do not refill the water reservoir with used hot water or the used descaling mixture.

- 9** Fill the water reservoir with fresh tap water up to the MAX indication again and repeat steps 3 to 6 once more.

Note: Always rinse the machine by letting it empty two full water reservoirs.

- 10** Remove the used pad and clean the pod holder after descaling to prevent the sieve or hole in the centre from getting clogged.

Storage

If the coffee machine has already been used and therefore has been flushed with water, it may only be used and stored in a frost-free place to prevent it from becoming damaged. Empty water reservoir before storing.

Assistance

For assistance, call toll free: 1-866-473-6736 or visit our website: www.senseo.com

Information is available 24 hours a day, 7 days a week.

Troubleshooting

If you have a problem, you may find the solution in the table below. If the table does not provide the solution to your problem or if you have a question, see chapter 'Assistance'.

Problem

Solution

The indicator light continues to blink slowly.

You have not yet flushed the coffee machine (see chapter 'Preparing the machine for use').

You have used the SENSEO® coffee machine at an altitude higher than 6800 Ft. / 2200 m above sea level. This has caused the water in the machine to start boiling before it has reached the required temperature, which prevents the machine from functioning properly. Switch the machine off and no longer use it at altitudes higher than 6800 Ft. / 2200 m above sea level.

The SENSEO® coffee machine does not produce coffee when used for the first time.

You have not yet flushed the coffee machine. When you use the machine for the first time, you have to flush it before you start brewing coffee (see chapter 'Preparing the machine for use').

The indicator light continues to blink rapidly.

Make sure that:

the water reservoir has been properly placed;

there is enough water in the water reservoir (i.e. above the  MIN level if you want to brew 1 cup);

the ambient temperature is not lower than 50°F / 10°C. If it is, the machine will not function properly.

Type HD7826/HD7824 only: the 2-cup button  cannot be operated.

Make sure that there is enough water in the water reservoir for brewing 2 cups of coffee. If the light ring around the 2-cup button  is out, there is not enough water in the water reservoir for brewing 2 cups.

Water leaks from the coffee machine.

Make sure that:

the lid is properly closed (the lever must be properly locked);

the water reservoir has not been filled beyond the MAX level;

Problem	Solution
	the sieve in the centre of the pod holder is not clogged. If it is, unplug the sieve by holding the pod holder under a running tap. If necessary, you can use a washing-up brush or a pin to unplug the sieve;
	the coffee pod has been put properly in the centre of the pod holder;
	the sealing ring has not got stuck under the edge of the water distribution disc (see figure 1 at the beginning of these instructions for use).
	the water drops on the worktop are not the result of placing or removing the water reservoir or removing used coffee pods.
	you do not remove the water reservoir when the coffee machine is heating up. This may cause water that normally ends up in the water reservoir to leak out of the machine.
	In all other cases, contact the Philips Consumer Care Centre in your country.
The coffee spout cannot be taken out of the machine.	The coffee spout can only be taken out after the coffee collector has been removed.
The lid cannot be opened.	A vacuum may have temporarily formed under the lid.
	Switch the machine off. Pull the lever up as far as it will go and wait 24 hours before opening the lid. You may need to use quite some force.
	Make sure that the sieve in the centre of the pod holder is not clogged. If it is, unplug the sieve by holding the pod holder under a running tap. If necessary, you can use a washing-up brush or a pin to unplug the sieve.
	Make sure you do not move the SENSEO® machine. Moving the machine, placing it outdoors or in a cool or cold environment does not accelerate the unlocking of the lid.
	Do NOT put the SENSEO® machine in the fridge or freezer, as this does not accelerate the unlocking of the lid.
	If problems continue to occur, contact the Philips Consumer Care Centre in your country.
The coffee machine produces less coffee than before.	Perhaps the sieve in the centre of the pod holder is clogged. If this is the case, unplug the sieve by rinsing the pod holder under a running tap. Use a washing-up brush to clean the sieve, if necessary.
	Descalcify the machine (see chapter 'Descaling').
The Senseo coffee machine brews only a small quantity of coffee or no coffee at all when it is used for the first time.	You have not flushed the machine properly before first use. As a result, the boiler is not or not completely filled. Flush the machine properly (see chapter 'Preparing the machine for use') before you brew another cup of coffee.
The lid cannot be closed properly.	Check if a used coffee pod is sticking to the water distribution disc. If this is the case, remove the used pod.
	Check if you used the correct pod holder: Use 2 pods in combination with the deeper 2-cup pod holder ☞☞. Use 1 pod in combination with the 1-cup pod holder ☞.

Problem	Solution
The machine has been stored in a room that was not frost-free.	Contact the Philips Consumer Care Centre in your country.
The SENSEO® coffee is not strong enough.	Make sure that:
	you have used the correct number of pods and have pressed the right button. Use 1 pod in combination with the 1-cup pod holder ☞ and the 1-cup button ☞. Use 2 pods in combination with the 2-cup pod holder ☞☞ and the 2-cup button ☞☞/☞☞;
	the coffee pod(s) have been placed properly in the centre of the pod holder, to prevent water from escaping along the edge of the pod(s). When you are using two coffee pods on top of each other, make sure that the convex sides of both pods are pointing downwards and press the pods lightly into the pod holder;
	you have not used the same pod twice by accident;
	the coffee in the pod is evenly distributed;
	If you prefer a more robust flavour, SENSEO® coffee pods with a stronger blend are available.
The SENSEO® coffee is too strong.	If you prefer a milder flavour, SENSEO® coffee pods with a milder blend are available.
The coffee is not hot enough.	Do not use cups that are too large, as they will cause the coffee to get cold more quickly. When using cups, make sure they have a capacity of 5 oz. When using a mug, make sure it has a capacity of 10 oz..
Water and steam have leaked from the bottom of the appliance in a fast way.	Your SENSEO® machine has a technical malfunction and has drained all water for safety reasons. The machine is blocked and does not function anymore. For assistance, please visit our website www.senseo.com or take the machine to a Philips service centre.

FULL TWO YEARS WARRANTY

Philips Electronics North America Corporation warrants each new Philips Product, model HD7826/7824/7820 (except cord, coffee pods and accessories) against defects in materials or workmanship for a period of two years from the date of purchase, and agrees to repair or replace any defective product without charge.

IMPORTANT: This warranty does not cover damage resulting from accident, misuse or abuse, lack of reasonable care, the affixing of any attachment not provided with the product or loss of parts or subjecting the product to any but the specified voltage.

* Use of unauthorized replacement parts will void this warranty.

PHILIPS ELECTRONICS NORTH AMERICA CORPORATION WILL NOT PAY FOR WARRANTY SERVICE PERFORMED BY A NON-AUTHORIZED REPAIR SERVICE AND WILL NOT REIMBURSE THE CONSUMER FOR DAMAGE RESULTING FROM WARRANTY SERVICE PERFORMED BY A NON-AUTHORIZED REPAIR SERVICE.

NO RESPONSIBILITY IS ASSUMED FOR ANY SPECIAL, INCIDENTAL, OR CONSEQUENTIAL DAMAGES.

In order to obtain warranty service, simply ship the product postage prepaid to the Philips Norelco Service Location (information available online at www.philips.com/norelco or at 1-866-473-6736). It is suggested that for your protection, you return shipments of product by insured mail, insurance prepaid. Damage occurring during shipment is not covered by this warranty.

NOTE: No other warranty, written or oral, is authorized by Philips Electronics North America Corporation. This warranty gives you specific legal rights, and you may also have other rights that vary from state to state. Some states do not allow the exclusion or limitation of incidental or consequential damages, so the above exclusion and limitations may not apply to you.

* Read enclosed instructions carefully.

Manufactured for:
Philips Consumer Lifestyle
A Division of Philips Electronics North America Corporation
1600 Summer Street, Stamford, CT 06912-0015

Call 1-866-4 Senseo (1-866-473-6736) or visit our website: www.senseo.com



This symbol on the product's nameplate means it is listed by Underwriters Laboratories, Inc.

PHILIPS and Philips Shield are Registered Trademarks of Koninklijke

Philips Electronics N.V.

Senseo is a Trademark of Koninklijke Philips Electronics N.V. when used for coffee makers.

Senseo is a Trademark of Sara Lee/NE N.V. when used for coffee pods.

Design and quality by Philips and Sara Lee Douwe Egberts.

2006 Philips Electronics North America Corporation. All Rights Reserved.

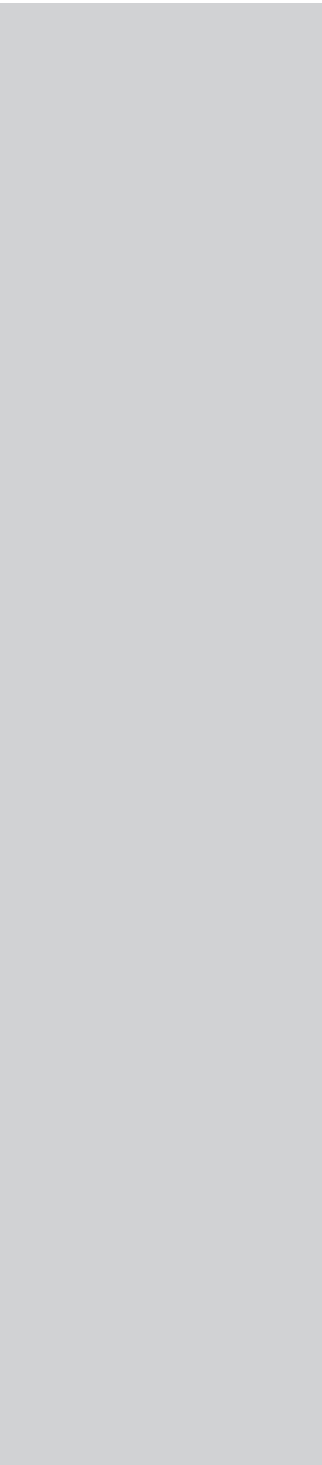

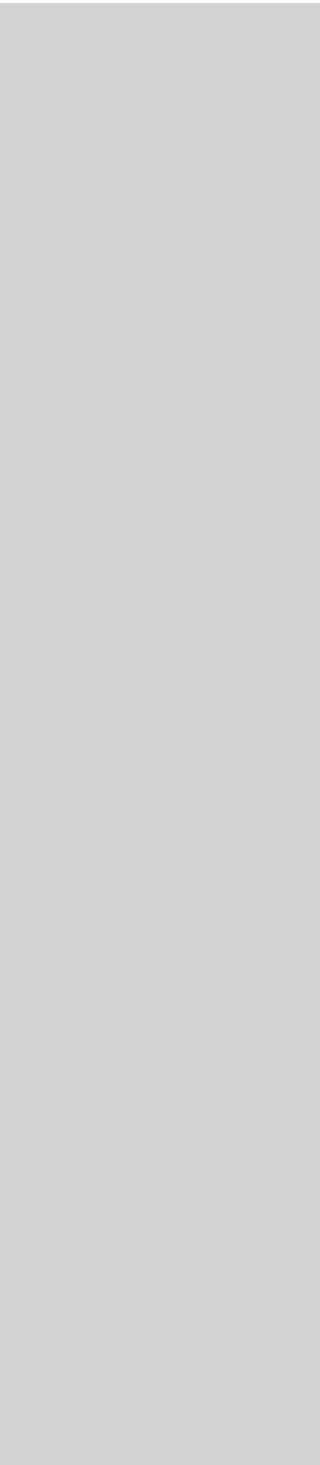

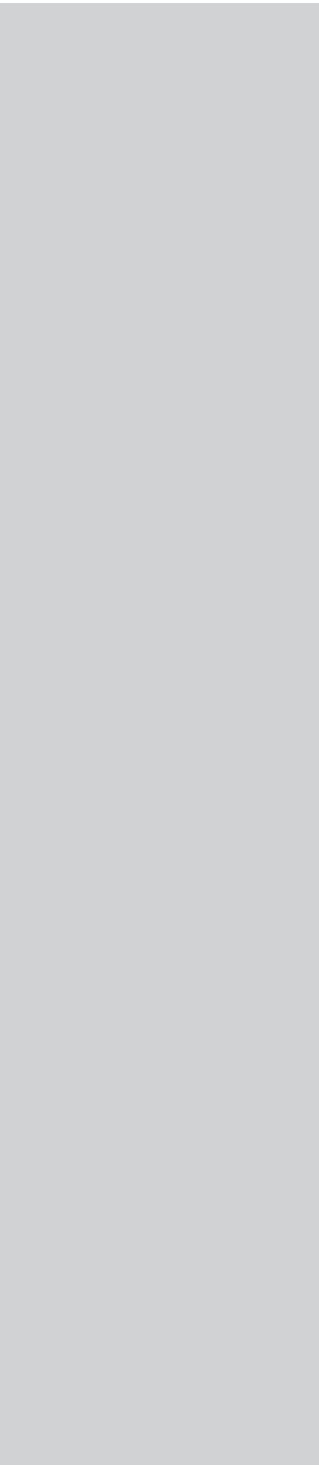



www.philips.com

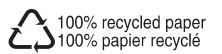

4222.200.0010.3