



PURE

OPERATING INSTRUCTIONS

Type HD8765

Read carefully before using the machine.



EN

02

FOR HOUSEHOLD USE ONLY



Register your product and get support at

www.philips.com/welcome

IMPORTANT SAFEGUARDS

When using electrical appliances, basic safety precautions should always be followed, including the following:

1. Read all instructions.
2. Do not touch hot surfaces. Use handles or knobs.
3. To protect against fire, electric shock and injury to persons do not immerse cord, plugs, or appliance in water or other liquid.
4. Close supervision is necessary when the appliance is used by or near children.
5. Unplug from outlet when not in use and before cleaning. Allow to cool before putting on or taking off parts, and before cleaning the appliance.
6. Do not operate any appliance with a damaged cord or plug or after the appliance malfunctions, or has been damaged in any manner. Return appliance to the nearest authorized service facility for examination, repair or adjustment.
7. The use of accessory attachments not recommended by the appliance manufacturer may result in fire, electric shock or injury to persons.
8. Do not use outdoors.
9. Do not let cord hang over edge of table or counter, or touch hot surfaces.
10. Do not place on or near a hot gas or electric burner, or in a heated oven.
11. Always attach plug to appliance first, then plug cord into wall outlet. To disconnect, turn any control to "off", then remove plug from wall outlet.
12. Do not use appliance for other than intended use.
13. Save these instructions.

SAVE THESE INSTRUCTIONS

CAUTION

This appliance is for household use only. Any servicing, other than cleaning and user maintenance, should be performed by an authorized service center. Do not immerse machine in water. To reduce the risk of fire or electric shock, do not disassemble the machine. There are no parts inside the machine serviceable by the user. Repair should be done by authorized service personnel only.

1. Check voltage to be sure that the voltage indicated on the nameplate corresponds with your voltage.
2. Never use warm or hot water to fill the water tank. Use cold water only.
3. Keep your hands and the cord away from hot parts of the appliance during operation.
4. Never clean with scrubbing powders or harsh cleaners. Simply use a soft cloth dampened with water.
5. For optimal taste of your coffee, use purified or bottled water. Periodic descaling is still recommended every 2-3 months.
6. Do not use caramelized or flavored coffee beans.

INSTRUCTIONS FOR THE POWER SUPPLY CORD

- A. A short power-supply cord (or detachable power-supply cord) is to be provided to reduce risks resulting from becoming entangled in or tripping over a longer cord.
- B. Longer detachable power-supply cords or extension cords are available and may be used if care is exercised in their use.
- C. If a long detachable power-supply cord or extension cord is used,
 1. The marked electrical rating of the detachable power-supply cord or extension cord should be at least as great as the electrical rating of the appliance
 2. If the appliance is of the grounded type, the extension cord should be a grounding-type 3-wire cord, and
 3. The longer cord should be arranged so that it will not drape over the counter top or table top where it can be pulled on by children or tripped over.

Congratulations on your purchase of a Saeco Minuto Pure fully automatic espresso machine!

*To fully benefit from the support that Saeco offers, please register your product at **www.philips.com/welcome**.*

The machine is suitable for preparing espresso coffees using whole coffee beans.

In this user manual you will find all the information you need to install, use, clean and descale your machine.

CONTENTS

INSTALLATION	4
Product Overview	4
General Description	5
PREPARING FOR USE	6
Machine Packaging	6
Machine Installation	6
USING THE MACHINE FOR THE FIRST TIME	8
Circuit Priming	8
Automatic Rinse/Self-Cleaning Cycle	9
Manual Rinse Cycle	10
"INTENZA+" Water Filter Installation	12
ADJUSTMENTS	13
Saeco Adapting System	13
Adjusting the Coffee Grinder	14
Adjusting the Coffee Dispensing Spout	15
Adjusting the Coffee Length	16
ESPRESSO AND COFFEE BREWING	17
FROTHING MILK/MAKING A CAPPUCCINO	18
Frothing milk	18
Making a cappuccino	19
HOT WATER DISPENSING	20
CLEANING AND MAINTENANCE	21
Daily Cleaning of the Machine	21
Daily Cleaning of the Water Tank	22
Daily Cleaning of the Classic Milk Frother	22
Weekly Cleaning of the Machine	23
Weekly Cleaning of the Classic Milk Frother	23
Weekly Cleaning of the Brew Group and of the Coffee Exit Duct	24
Monthly Lubrication of the Brew Group	27
Monthly Cleaning of the Coffee Bean Hopper	28
DESCALING	29
WARNING SIGNALS	34
TROUBLESHOOTING	38
ENERGY SAVING	40
Stand-by	40
TECHNICAL SPECIFICATIONS	41
WARRANTY AND SERVICE	41
Warranty	41
Service	41
ORDERING MAINTENANCE PRODUCTS	42

INSTALLATION

Product Overview

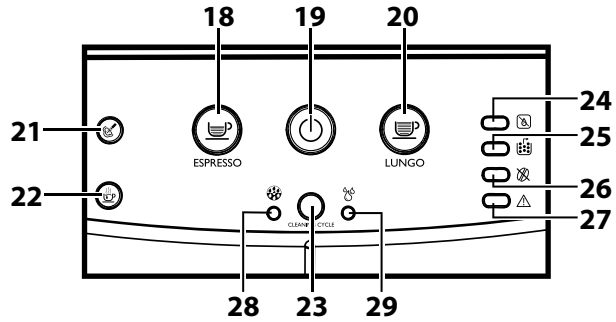
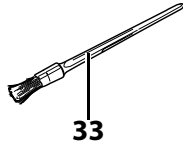
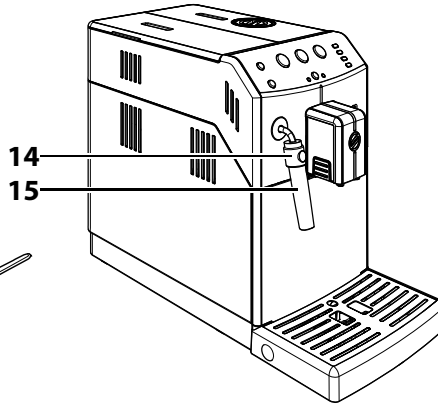
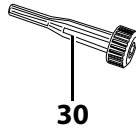
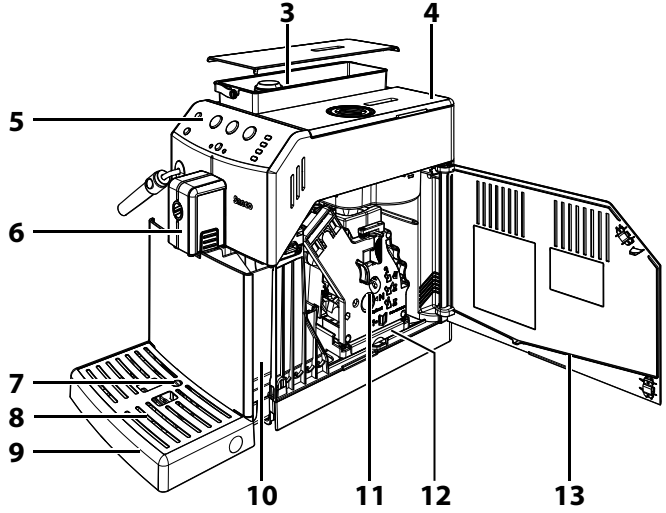
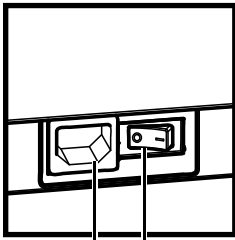
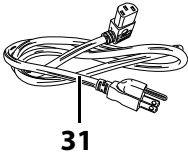
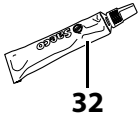
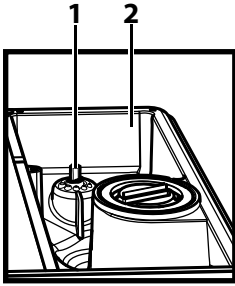

General Description

1. Grinder adjustment knob
2. Coffee bean hopper
3. Water tank + Lid
4. Coffee bean hopper lid
5. Control panel
6. Coffee Dispensing spout
7. Full drip tray indicator
8. Cup holder grill
9. Drip tray
10. Coffee grounds drawer
11. Brew group
12. Coffee residues drawer
13. Service door
14. Wand protective gripper
15. Classic Milk Frother (for hot water/steam)
16. Power cord socket
17. Power button
18. Espresso brew button
19. ON/OFF button
20. Coffee brew button
21. Steam button
22. Hot water button
23. Descaling button
24. No water light
25. Empty coffee grounds drawer light
26. No coffee light
27. General warning light
28. Descaling cycle light
29. Rinse cycle light
30. Coffee grinder adjustment key
31. Power cord
32. Grease for the brew group - to be purchased separately
33. Cleaning brush - to be purchased separately
34. Descaling solution- to be purchased separately

PREPARING FOR USE

Machine Packaging

The original packaging has been designed and constructed to protect the machine during transport. We recommend keeping the packaging material for possible future transport.

Machine Installation

1 Remove the machine from the packaging.

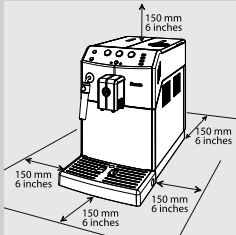

2 For best use, it is recommended to:

- choose a safe, level surface, where there will be no danger of overturning the machine or being injured;
- choose a location that is sufficiently well-lit, clean and near an easily reachable socket;
- allow for a minimum distance from the sides of the machine as shown in the illustration.

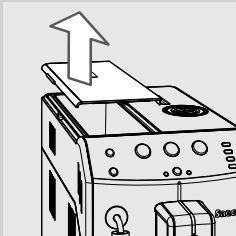

3 Remove the water tank lid.

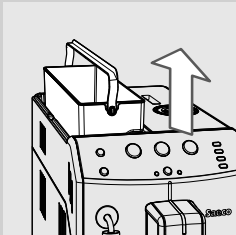

4 Lift the water tank using the handle.

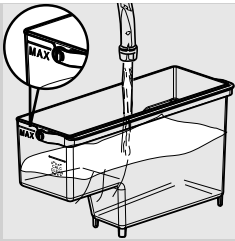

5 Rinse the water tank with fresh water.

6 Fill the water tank with fresh water up to the MAX level and reinsert it into the machine. Make sure it is fully inserted.



Caution:

Never fill the water tank with warm, hot, sparkling water or any other liquid, as this may cause damage to the water tank and the machine.

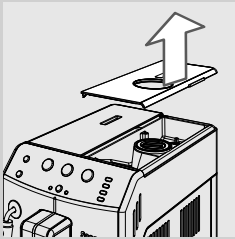

7 Remove the coffee bean hopper lid.

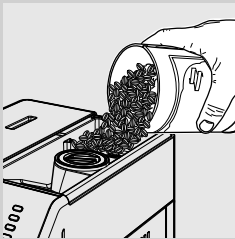

8 Slowly pour the coffee beans into the coffee bean hopper.



Note:

Do not pour too many coffee beans into the coffee bean hopper as this will reduce the grinding performance of the machine.



Caution:

Only coffee beans must be put into the coffee bean hopper. Ground coffee, instant coffee, caramelized coffee or any other object may damage the machine.

9 Put the lid back on the coffee bean hopper.

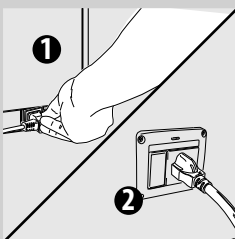

10 Insert the plug into the socket located on the back of the machine.

11 Insert the plug at the other end of the power cord into a wall socket with suitable power voltage.

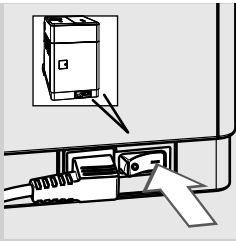

12 Switch the power button to "I" to turn on the machine. The "⏻" button flashes.



13 To turn on the machine simply press the "⏻" button.

USING THE MACHINE FOR THE FIRST TIME

When using the machine for the first time, the following activities need to happen:

- 1) you need to prime the circuit;
- 2) the machine will perform an automatic rinse/ self-cleaning cycle;
- 3) you need to initiate a manual rinse cycle.

Circuit Priming

During this process fresh water flows through the internal circuit of the machine and the machine warms up. This takes a few minutes.

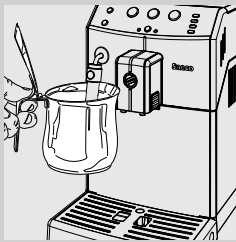

1 Place a container under the hot water/steam wand.

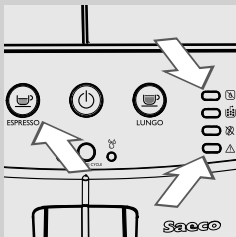

2 The "⊠" light and the "⚠" light flash simultaneously; then the "☺" button lights up. To prime the circuit, press the "☺" button.

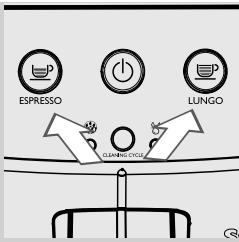

- 3 The machine warms up; the “☕” and “☕” buttons flash simultaneously.

Automatic Rinse/Self-Cleaning Cycle

When warm-up is complete, the machine automatically performs a rinse/self-cleaning cycle of the internal circuit with fresh water. This takes less than a minute.



- 1 Place a container under the coffee dispensing spout to catch the water which will be dispensed.

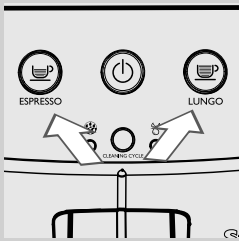

- 2 The “☕” and “☕” buttons flash simultaneously. Wait for the cycle to finish automatically.

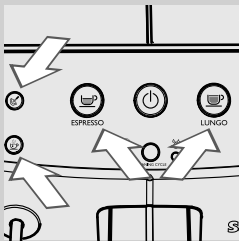

- 3 When the cycle has finished the “☕”, “☕”, “⚡” and “☕” buttons are steady on. You can now perform the manual rinse cycle.

Manual Rinse Cycle

During this process you activate the coffee brewing cycle and fresh water flows through the water circuit. This takes a few minutes.



- 1 Place a container under the coffee dispensing spout.

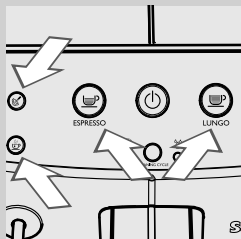

- 2 Check that the “☕”, “☕”, “☕” and “☕” buttons are steady on.



- 3 Press the “☕” button. The machine starts brewing coffee. Wait until brewing has finished and empty the container.



- 4 Place the container under the Classic Milk Frother.



5 Press the “☕” button to dispense hot water.

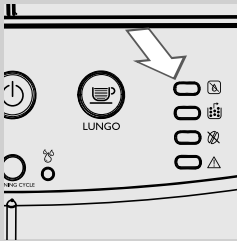

6 Dispense all the remaining water. The “☕” light is steady on.



Note:

Press the “☕” button to interrupt the manual rinse cycle. The cycle can be restarted by pressing the “☕” button.

7 Fill the water tank again up to the MAX level. Now the machine is ready for coffee brewing.



Note:

When you haven’t used the machine for 2 or more weeks, the machine will automatically perform an automatic rinse/self-cleaning cycle after you switch it on. Following this, you need to initiate a manual rinse cycle as described above.

The automatic rinse/self-cleaning cycle also starts when the machine has been in stand-by mode or switched off for more than 15 minutes. After this cycle has finished, you can brew a coffee.

“INTENZA+” Water Filter Installation

We recommend you to install the “INTENZA+” water filter as this prevents limescale build-up in your machine and preserves a more intense aroma of your coffee.



The “INTENZA+” water filter can be purchased separately. For further details, please refer to the maintenance products page in this user manual. Water is a crucial part of every coffee, so it is very important to always have it professionally filtered. Using the “INTENZA+” water filter will prevent mineral deposits from building up and improve your water quality.

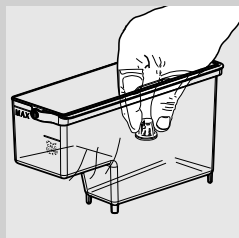

- 1 Remove the small white filter from the water tank and store it in a dry place.

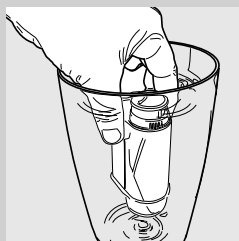

- 2 Remove the “INTENZA+” water filter from its packaging, immerse it vertically (with the opening positioned upwards) in cold water and gently press the sides so as to let the air bubbles out.

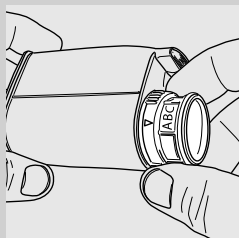

- 3 Set the “INTENZA+” water filter according to the hardness of the water used:
 - A = Soft water
 - B = Hard water (standard)
 - C = Very hard water

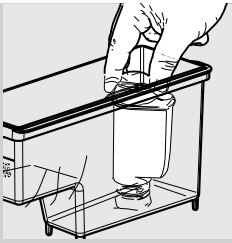

4 Put the "INTENZA+" water filter into the empty water tank. Press it down until it cannot move any further.

5 Fill the water tank with fresh water and reinsert it into the machine.

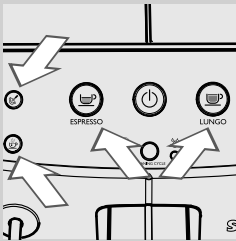

6 Check that the "ESPRESSO", "POWER", "LUNGO" and "WATER" buttons are permanently on.

7 Press the "POWER" button to dispense hot water.

8 Dispense all water in the tank. The "WATER" light is steady on.

9 Fill the water tank again with fresh water and reinsert it into the machine.

10 Now the "ESPRESSO", "LUNGO", "POWER" and "WATER" buttons are steady on.



Note:

We recommend you to replace the Intenza + filter every 2 months.

ADJUSTMENTS

The machine allows for certain adjustments so that you can brew the best tasting coffee possible.

Saeco Adapting System

Coffee is a natural product and its characteristics may change according to its origin, blend and roast. The machine is equipped with a self-adjusting system that allows the use of all types of coffee beans available on the market except for caramelized and flavoured coffee beans.

The machine automatically adjusts itself after brewing a certain number of cups of coffee to optimise the extraction.

Adjusting the Coffee Grinder.

You can adjust the grinder to set the coffee grinding to your personal taste.



Warning:

The coffee grinder contains moving parts that may be dangerous. Do not insert fingers or other objects. Only adjust the coffee grinder using the grinder adjustment key.



Warning:

The grinder adjustment knob, inside the coffee bean hopper, must be turned only one notch at a time.

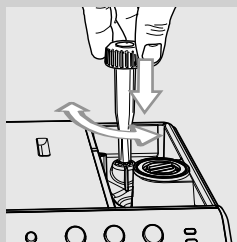

- 1** Press and turn the grinder adjustment knob inside the coffee bean hopper one notch at a time. Use the special coffee grinder adjustment key supplied. You will taste the difference after brewing 2-3 cups of coffee.

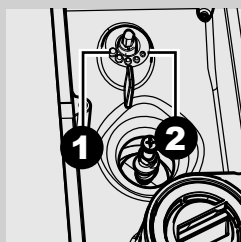

- 2** The reference marks inside the coffee bean hopper indicate the grind setting. There are 5 different grind settings to choose from: position 1 for coarse grind - lighter taste to position 2 for fine grind - bolder taste.

Adjusting the Coffee Dispensing Spout

The height of the dispensing spout can be adjusted to better fit the dimensions of the cups that you wish to use.

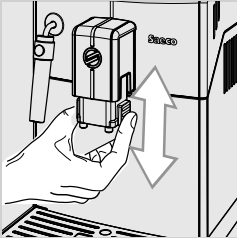

Move the dispensing spout up or down with your fingers to adjust its height as shown in the image.

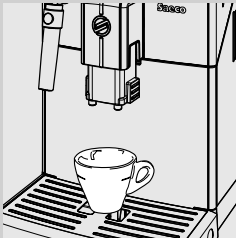

The recommended positions are:
For the use of small cups;



For the use of large cups.

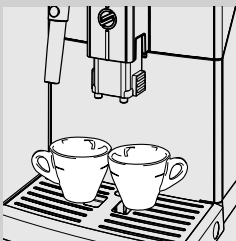

Two cups can also be placed under the dispensing spout to brew two cups of espresso or two cups of coffee at the same time.

Adjusting the Coffee Length

The machine allows you to adjust the amount of brewed coffee according to your taste and the size of your cups.

Each time the “☕” or “☕” button is pressed, the machine brews a pre-set amount of coffee. Each button may be individually programmed for a specific brew setting.

The following procedure describes how to programme the “☕” button.

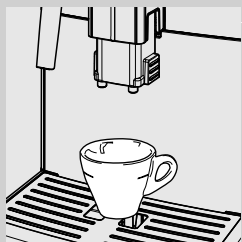

- 1 Place a cup under the dispensing spout.



- 2 Press and hold the “☕” button until it starts to flash quickly. Then release the button. The machine is now programming. The “☕” button flashes during the programming cycle. The machine starts brewing coffee.

- 3 Press the “☕” button as soon as the desired amount of coffee is reached.

Now the “☕” button is programmed; each time it is pressed, the machine will brew the same amount of espresso that was just programmed.



Note:

Follow the same procedure to program the “☕” button.

Press the “☕” button to stop brewing when the desired amount of coffee is reached.

ESPRESSO AND COFFEE BREWING

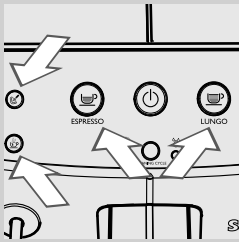

Before brewing coffee, make sure that the machine is ready to use and that the water tank and coffee bean hopper are filled. The “☕”, “☕”, “☕” and “☕” buttons are steady on.

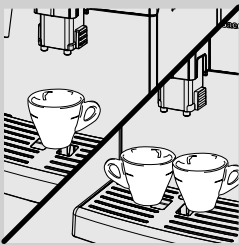

1 Place 1 or 2 cups under the dispensing spout.

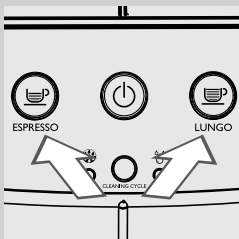

2 Press the “☕” button for an espresso or the “☕” button for a coffee.

3 To brew 1 cup of espresso or coffee, press the desired button once. The pressed button flashes slowly.

4 To brew 2 cups of espresso or coffee, press the desired button twice consecutively. The pressed button flashes quickly twice.

Note:

In this operating mode, the machine automatically grinds and doses the correct amount of coffee. Brewing two espressos or two coffee requires two grinding and brewing cycles, automatically carried out by the machine.

5 After the prebrewing cycle, coffee begins to pour out of the dispensing spout.

6 Coffee brewing automatically stops when the preset level is reached; press the same button pressed previously to stop it earlier.

FROTHING MILK/MAKING A CAPPUCCINO



Warning:

Danger of burning! Dispensing may be preceded by small jets of hot water. The Classic Milk Frother may reach high temperatures. Never touch it with bare hands. Use the appropriate protective handle only.

Frothing milk

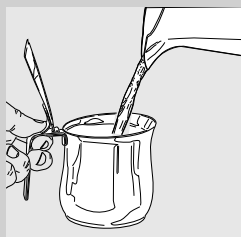

- 1 Fill 1/3 of a container with cold milk.



Note:

When preparing your cappuccino, use cold (~5°C / 41°F) milk with a protein content of at least 3% to ensure optimum results. Whole milk or skimmed milk may be used depending on individual taste.



Note:

When you plan to dispense steam right after switching on the machine or after brewing a coffee, some water still present in the circuit may need to be dispensed first. To do this, press the "☕" button to dispense steam for a few seconds. Thereafter press the "☕" button again to stop dispensing. Continue with step 2.

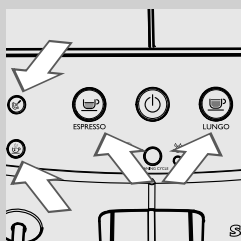

- 2 Before dispensing steam, make sure that the machine is ready to use and the water tank is filled. The "☕", "☕", "☕" and "☕" buttons are steady on.

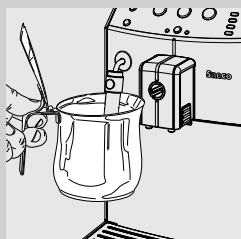

- 3 Immerse the Classic Milk Frother in the milk.

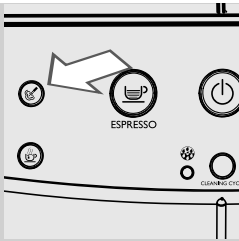

4 Press the “☁️” button to dispense steam.

5 The “☁️” button flashes slowly during the warm-up time required by the machine. Once the warm-up phase has finished, steam dispensing begins and the “☁️” button flashes.

6 Froth the milk by gently swirling the container and moving it up and down.

7 When the milk froth has the desired consistency, press the “☁️” button to stop steam dispensing.



Note:

After having pressed the “☁️” button it will take a few seconds before the machine stops dispensing steam completely: the “☁️” button flashes quickly during this time.

Note:

Steam dispensing stops after 3 minutes. Press the “☁️” button to start dispensing steam again.

Caution:

After frothing the milk, a small quantity of hot water must be dispensed into a container. Remove the external part of the Classic Milk Frother and wash it with lukewarm water.

Note:

After dispensing steam, it is possible to brew an espresso or a coffee, or dispense hot water, straight after.

Making a cappuccino

To make a cappuccino place your cup with frothed milk under the coffee dispensing spout and brew an espresso.

HOT WATER DISPENSING

**Warning:**

Danger of burning! Dispensing may be preceded by small jets of hot water. The Classic Milk Frother may reach high temperatures: never touch it with bare hands. Use the appropriate protective handle only.

Before dispensing hot water, make sure that the machine is ready to use and the water tank is filled. The “☕”, “☕”, “☕” and “☕” buttons are steady on.

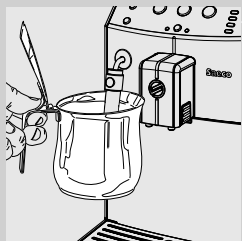
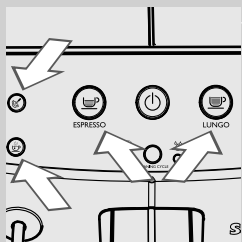

- 1 Place a container under the Classic Milk Frother.

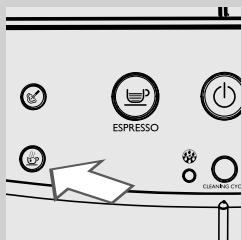

- 2 Press the “☕” button to dispense hot water.

- 3 The “☕” button flashes slowly during the warm-up time required by the machine. Once the warm-up phase has finished, hot water dispensing begins and the “☕” button flashes slowly.

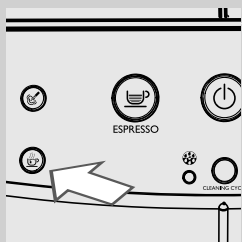

- 4 Pour the desired amount of hot water. To stop the hot water dispensing, press the “☕” button.

CLEANING AND MAINTENANCE

Daily Cleaning of the Machine



Caution:

Timely cleaning and maintenance of your machine is very important as it prolongs the life of your machine. Your machine gets exposed to moist, coffee and lime scale continuously!

In this chapter it is described in detail which activities you need to perform at which frequency. Not doing this will ultimately make your machine stop working properly. This repair is NOT covered by your warranty.



Note:

- Use a soft, dampened cloth to clean the machine.
- Only the cup holder grill can be washed in the dishwasher. All other components must be washed with lukewarm water.
- Do not immerse the machine in water.
- Do not use alcohol, solvents, and/or abrasive objects to clean the machine.
- Do not dry the machine and/or its components using a microwave and/or standard oven.

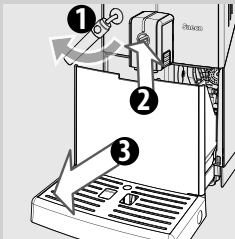

- 1** Empty and clean the coffee grounds drawer and the drip tray daily with the machine turned on.

Other maintenance operations can only be carried out when the machine is turned off and unplugged.

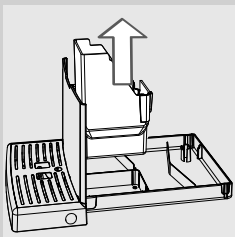

- 2** Remove the coffee grounds drawer and empty it.
- 3** Empty and clean the drip tray.

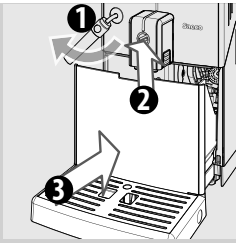

- 4 Insert the coffee grounds drawer back into the drip tray and this into the machine.

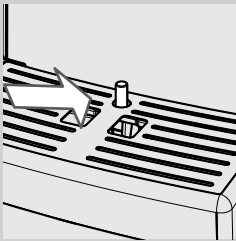

Note:

Also empty the drip tray and coffee grounds drawer when the full drip tray indicator is raised.

Daily Cleaning of the Water Tank

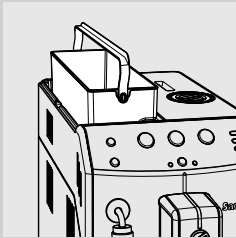

- 1 Remove the small white filter or the "INTENZA+" water filter (if installed) from the water tank and wash it with fresh water.
- 2 Put the small white filter or the "INTENZA+" water filter (if installed) back in its housing by gently pressing and turning it at the same time.
- 3 Fill the water tank with fresh water up to the MAX level.

Daily Cleaning of the Classic Milk Frother

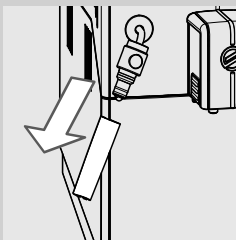

It is important that you clean the Classic Milk Frother daily or after each use as it preserves hygiene and ensures perfect milk froth consistency.

After frothing the milk, a small quantity of hot water must be dispensed into a container.

Remove the external part of the Classic Milk Frother and wash it with lukewarm water.

Weekly Cleaning of the Machine

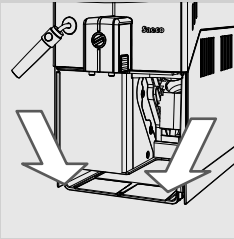

- 1 Clean the seat of the drip tray.

Weekly Cleaning of the Classic Milk Frother

The weekly cleaning is more thorough, since you need to disassemble all the Classic Milk Frother components.

The following cleaning operations are required:

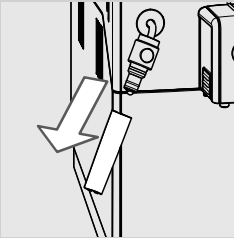

- 1 Remove the external part of the Classic Milk Frother. Wash it with lukewarm water.

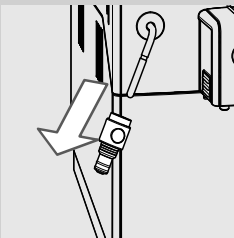

- 2 Remove the upper part of the Classic Milk Frother from the steam/hot water wand.
- 3 Wash the upper part of the Classic Milk Frother with fresh water.
- 4 Clean the steam/hot water wand of the Classic Milk Frother with a wet cloth to remove milk residues.
- 5 Put the upper part back into the steam/hot water wand (make sure it is completely inserted).
- 6 Reassemble the external part of the Classic Milk Frother.

Weekly Cleaning of the Brew Group and of the Coffee Exit Duct

The brew group should be cleaned every time the coffee bean hopper is filled or at least once a week.

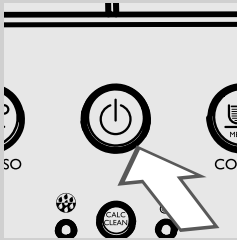

- 1 Turn off the machine by pressing the “⏻” button and unplug the power cord.

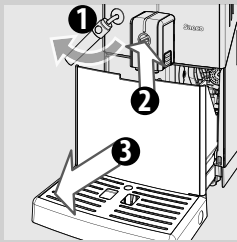

- 2 Remove the drip tray and coffee grounds drawer. Only at this time open the service door.

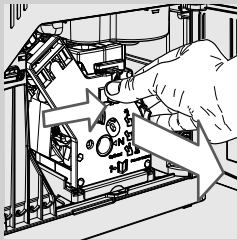

- 3 To remove the brew group, press the «PUSH» button and pull it by the handle. Pull it out horizontally without turning it.

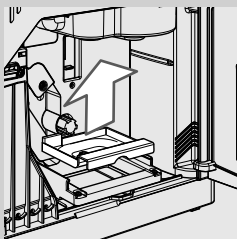

- 4 Remove the coffee residues drawer and wash it thoroughly.

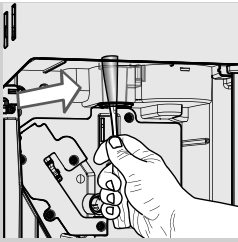

- 5** Clean the coffee exit duct thoroughly with a spoon handle or with another round-tipped kitchen utensil.

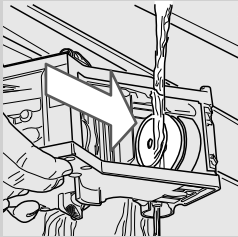

- 6** Thoroughly wash the brew group with fresh, lukewarm water and carefully clean the upper filter.



Caution:

Do not use detergent or soap to clean the brew group.

- 7** Let the brew group air-dry thoroughly.

- 8** Thoroughly clean the inside of the machine using a soft, dampened cloth.

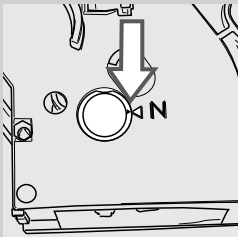

- 9** Make sure the brew group is in the off position; the two reference signs must match. If they do not match, proceed as described in step (10).

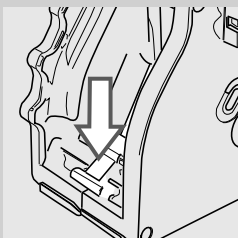

- 10** Gently pull down the lever until it is in contact with the brew group base and the two reference signs on the side of the brew group match.

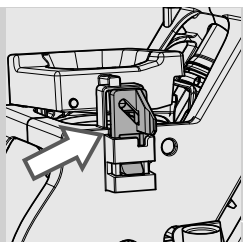

- 11** Make sure the hook to lock the brew group is in the correct position by firmly pressing the "PUSH" button until it locks into place. Check if the hook is at the top end position. If it is not, please try again.

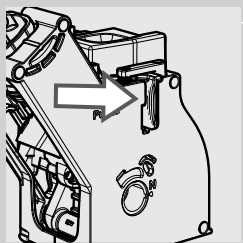

- 12** Insert the coffee residues drawer in its seat and ensure that it is correctly in place.



Note:

If the coffee residues drawer is not correctly positioned, the brew group may not fit into the machine.

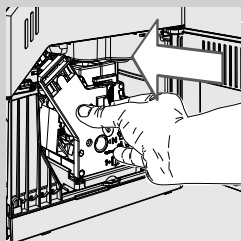
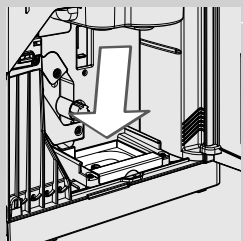

- 13** Insert the brew group in its seat again until it locks into place without pressing the "PUSH" button.

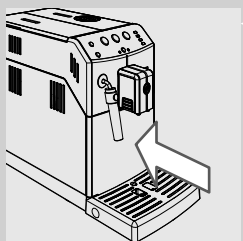

- 14** Insert the coffee grounds drawer with the drip tray back into the machine and close the service door.

Monthly Lubrication of the Brew Group

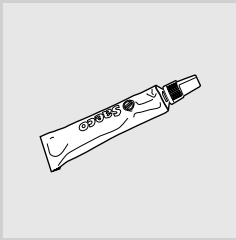

Lubricate the brew group after approximately 500 cups of coffee or once a month.

The grease to lubricate the brew group can be purchased separately. For further details, please refer to the maintenance products page in this user manual.



Caution:

Before lubricating the brew group, clean it with fresh water and let it dry, as described in the “Weekly Cleaning of the Brew Group” chapter.

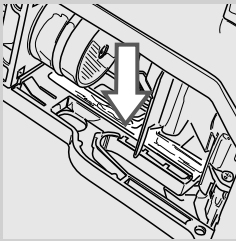

- 1** Apply the grease evenly on both side guides.

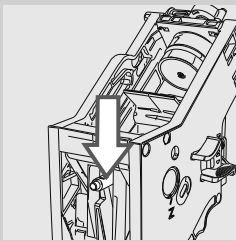
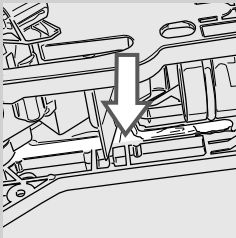

- 2** Also lubricate the shaft.

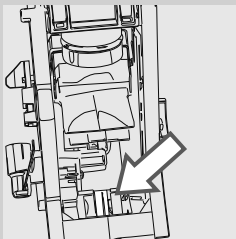

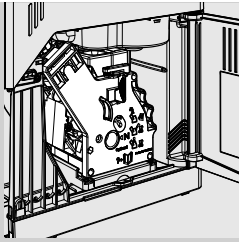

3 Insert the brew group in its seat until it locks into place (see the “Weekly Cleaning of the Brew Group” chapter).

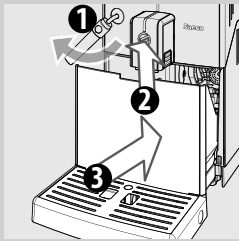

4 Insert the coffee grounds drawer with the drip tray back into the machine and close the service door.

Monthly Cleaning of the Coffee Bean Hopper

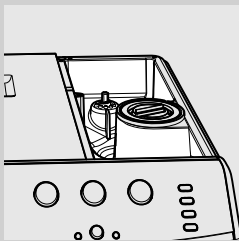

Clean the coffee bean hopper once a month when it is empty with a damp cloth to remove coffee oil. Thereafter refill it with coffee beans.

DESCALING

The descaling process takes approx. 35 minutes.

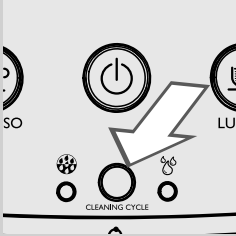

Limescale builds up inside the machine during use. It needs to be removed regularly as it may clog the water and coffee circuit of your machine. The machine indicates when descaling is needed. When the "CLEANING CYCLE" button is steady on, the machine needs descaling.



Caution:

Not doing this will ultimately make your machine stop working properly, and in this case repair is NOT covered by your warranty.

Use the Saeco descaling solution only. Its formula has been designed to ensure better machine performance.



You can purchase separately the Saeco descaling solution. Please refer to the maintenance products page in this user manual for further details.



Warning:

Never drink the descaling solution or any products dispensed until the cycle has been carried out to the end. Never use vinegar as a descaling solution.



Note:

During the descaling cycle do not switch off the machine. If this has happened you have to restart the descaling cycle to fully complete it. It will restart from the point the descaling cycle had previously been left.

To execute the descaling cycle, follow the steps below:

Before descaling:

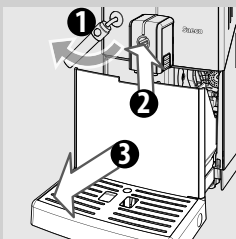

- 1 Empty the drip tray and the coffee grounds drawer.

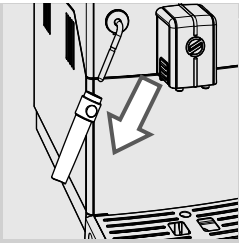

2 Remove the Classic Milk Frother from the steam/hot water wand.

3 Remove the water tank and remove the "INTENZA+" water filter from the water tank if it was installed and replace it with the small white original one.

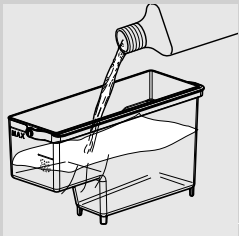

4 Pour the entire content of the descaling solution into the water tank and fill it with fresh water up to the calc clean level.

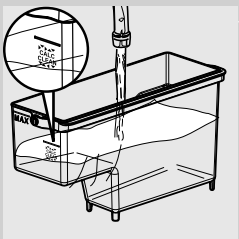

5 Place the water tank back into the machine.

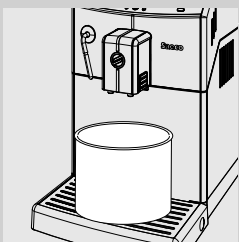

6 Place a large container (1.5l / 50.7 ounces) under both the steam/hot water wand and the dispensing spout.

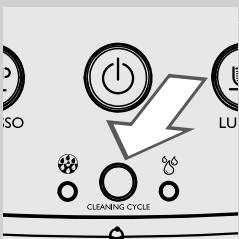

7 Press and hold the "CLEANING CYCLE" button for at least 3 seconds to start the descaling process. The "CLEANING CYCLE" button will begin to flash and will only stop when the descaling process is finished.

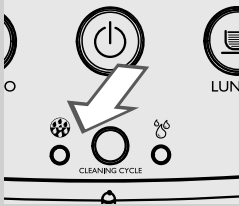

- 8** The machine will begin dispensing the descaling solution through the steam/hot water wand at intervals. This takes approx. 25 min. During this phase the “☼” light is steady on.



Note:

The descaling cycle may be paused by pressing the “☼” button. To continue the cycle, press the “☼” button again. During the pause the “☼” button flashes. During the descaling cycle the “☼” button is steady on. This allows you to empty the container or to stay away from the machine for a brief period of time.



- 9** When the “☼” light is steady on, the water tank is empty.

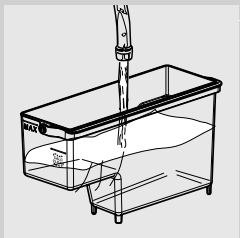

- 10** Remove the water tank, rinse it and fill it up to the MAX level with fresh water.

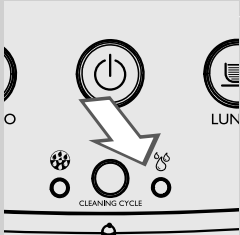

- 11** Place the water tank back into the machine. The “☼” light turns on.

- 12** Empty the container used to collect the descaling solution.

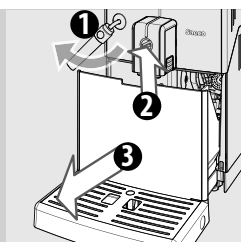

13 Empty the drip tray and coffee grounds drawer and place them back.

14 Put the container back under both the steam/hot water wand and the coffee dispensing spout.

15 When the “☕” button flashes, press it to start the rinse cycle.

Note:

The rinse cycle may be paused by pressing the “☕” button. To continue the cycle, press the “☕” button again. During the pause the “☕” button flashes. During the descaling cycle the “☕” button is steady on. This allows you to empty the container or to stay away from the machine for a brief period of time.



16 When the “☕” light is steady on, the water tank is empty. Repeat steps 9-15. When the “☕” light is steady on again, go to step 17.

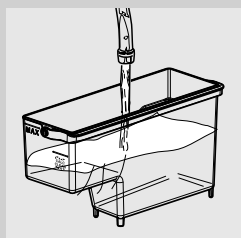

17 When the water tank is empty, remove it, rinse it and fill it up to the MAX level with fresh water. Place it back into the machine.

Note:

The circuit must be cleaned with a preset quantity of water. If the water tank is not filled up to MAX level, the machine might require three or more refills for rinsing.

18 When the amount of water needed for the rinse cycle has been completely dispensed the cleaning cycle button turns off, the “☕” button is steady on and the “☕” and “⚠️” lights flash to indicate that the machine needs to be primed.



- 19** Press the “☕” button to prime the circuit. During priming the “☕” and “⚠️” keep on flashing. They stop flashing when the priming is finished.

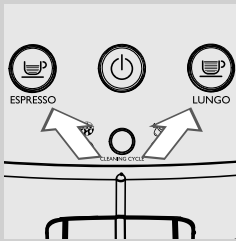

- 20** The “☕” and “☕” buttons flash simultaneously; the machine carries out the warm-up and automatic rinse cycle to prepare for coffee brewing.

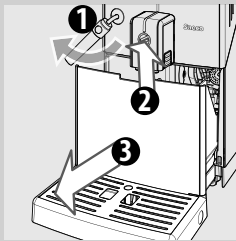

- 21** The descaling cycle is now complete.
- 22** Remove and empty the container.
- 23** Empty the drip tray and coffee grounds drawer and place them back.
- 24** Remove the small white filter and place back the “INTENZA+” water filter into the water tank if it was installed.

Note:

At the end of the descaling cycle, wash the brew group as described in the “Weekly Cleaning of the Brew Group” chapter.

WARNING SIGNALS

Warning signals



Flashing

The machine is performing one of the following operations:
 - Warm-up
 - Automatic rinse.



"☕" steady on and "🌀" and "⚠️" flashing

You have to prime the machine by pressing the espresso button. Once pressed, the "☕" button turns off. During priming the "🌀" and "⚠️" keep on flashing. They stop flashing when the priming is finished.



Steady on

The machine is ready for use.



Flashing slowly

The machine is brewing one cup of espresso.



Flashing slowly

The machine is brewing one cup of coffee.



Quickly double flashing

The machine is brewing two cups of espresso.

Warning signals

7

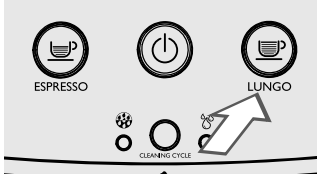

The machine is brewing two cups of coffee.

Quickly double flashing

8

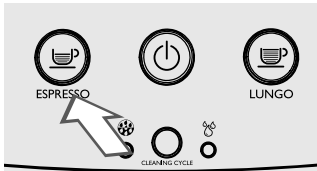

The machine is programming the amount of espresso to brew.

Flashing quickly

9

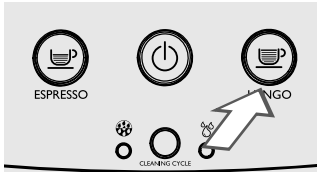

The machine is programming the amount of coffee to be brewed.

Flashing quickly

10



The machine is dispensing steam.

Flashing slowly

11



The machine is in the stop steam dispensing phase

Flashing quickly

12



The machine is dispensing hot water.

Flashing slowly

Warning signals

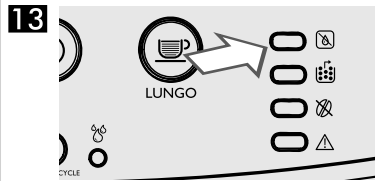

Fill the water tank.

Steady on

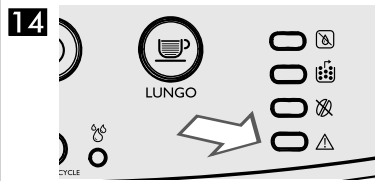

Completely insert the drip tray with the coffee grounds drawer into the machine and close the service door.

Steady on

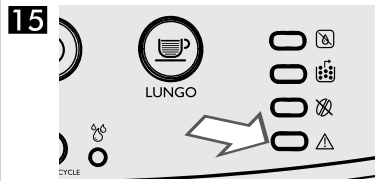

The brew group is being reset due to machine reset.

Flashing quickly



Insert the brew group properly.

Flashing slowly

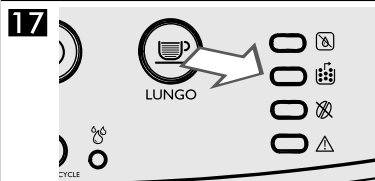

Empty the coffee grounds drawer.

Steady on

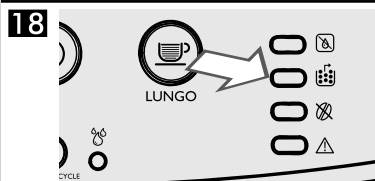

The coffee grounds drawer is not inserted into the machine. Wait a few seconds till the "☒" goes out and the "⚠" is steady on. Then insert the coffee grounds drawer in the machine and close the service door.

Flashing

Warning signals

19

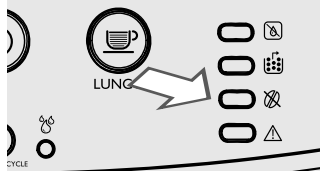

Steady on

Refill the coffee bean hopper with coffee beans and try again to make a coffee. The light turns off only when the bean hopper lid has been placed back.

It is possible to dispense steam and hot water when this warning light shows.

20

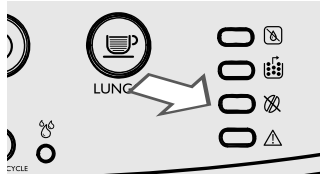

Flashing slowly

The bean hopper lid has been removed after having selected a coffee product. Put the lid back on.

21

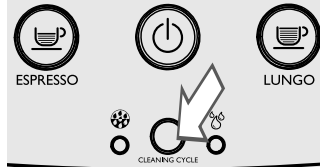

Steady on

The machine needs to be descaled. Follow the steps described in the “Descaling” chapter of this manual.

Please note that not descaling your machine will ultimately make it stop working properly. In this case repair is NOT covered under your warranty.

22



All lights flashing simultaneously

Turn off the machine. Turn it back on after 30 seconds. Repeat the procedure 2 or 3 times. If the machine does not start, contact the Philips SAECO hotline in your country (contact details in the warranty booklet)

TROUBLESHOOTING

This chapter summarizes the most common problems you could encounter with your machine.

If you are unable to solve the problem with the information below, visit www.philips.com/support for a list of frequently asked questions or contact the Philips Saeco hotline in your country.

The contact details can be found in the warranty booklet supplied separately or on www.philips.com/support.

Machine actions	Causes	Solutions
The machine does not switch on.	The machine is not connected to the electric network, or the power button is in the "O" position.	Connect the machine to the electric network and turn the power button to the "I" position.
The drip tray gets filled although no water is drained.	Sometimes water is drained automatically by the machine into the drip tray to manage the rinsing of the circuits and ensure optimum machine performance.	This is a standard operating procedure.
The "☕" light is always displayed on the machine.	The coffee grounds drawer was emptied with the machine off.	The coffee grounds drawer must always be emptied with the machine on.
Coffee is not hot enough.	The cups are cold.	Preheat the cups with hot water.
Coffee is not creamy enough (see note).	The blend is unsuitable, coffee is not freshly roasted or the grind is too coarse.	Change coffee blend or adjust the grind setting as explained in the chapter "Adjusting the Coffee Grinder".
The machine takes a long time to warm up or the amount of water dispensed is too little.	The machine circuit is clogged by limescale.	Descale the machine.
The brew group cannot be removed.	The brew group is out of place.	Turn on the machine. Close the service door. The brew group automatically returns to the initial position.
	The coffee grounds drawer is inserted.	Remove the coffee grounds drawer before removing the brew group.
The machine grinds the coffee beans but no coffee comes out (see note)	The brew group is dirty.	Clean the brew group (see the "Weekly Cleaning of the Brew Group" chapter).
	This might occur when the machine is automatically adjusting the dose.	Brew a few cups of coffee as described in the "Saeco Adapting System" chapter.
	The dispensing spout is dirty.	Clean the dispensing spout.
Coffee is too weak. (see note)	This might occur when the machine is automatically adjusting the dose.	Brew a few cups of coffee as described in the "Saeco Adapting System" chapter.

Machine actions	Causes	Solutions
Coffee is brewed slowly. (see note)	The coffee grind is too fine.	Change coffee blend or adjust the grind as explained in the chapter "Adjusting the Coffee Grinder".
	The brew group is dirty.	Clean the brew group (see the "Weekly Cleaning of the Brew Group" chapter).
Coffee leaks out of the dispensing spout.	The dispensing spout is clogged.	Clean the dispensing spout and its holes.
No hot water or steam is dispensed.	The hole of the steam/hot water wand is clogged.	Clean the hole of the steam wand using a pin. Make sure that the machine is off and has cooled down before doing this.
	The Classic Milk Frother is dirty.	Clean the Classic Milk Frother.

**Note:**

These problems can be considered normal if the coffee blend has been changed or if the machine has just been installed. In this case wait until the machine performs a self-adjusting operation as described in the "Saeco Adapting System" chapter.

ENERGY SAVING

Stand-by

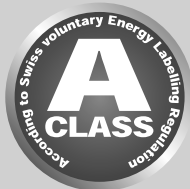

The Saeco fully automatic espresso coffee machine is designed for energy saving proven by the Class A energy label.

After 30 minutes of inactivity, the machine turns off automatically. If a product has been brewed the machine performs a rinse cycle.

In stand-by mode, the energy consumption is below 1Wh.
To turn on the machine, press the "⏻" button (if power button on the back of the machine is set to "I"). If the boiler is cold the machine performs a rinse cycle.

TECHNICAL SPECIFICATIONS

The manufacturer reserves the right to make changes to the technical specifications of the product.

Nominal Voltage - Power Rating - Power Supply	See label on the inside of the service door
Housing material	Thermoplastic material
Size (w x h x d)	215 x 330 x 429 mm / 8.5 x 13 x 16.9 inches
Weight	7 kg / 16 pounds
Power cord length	800 - 1200 mm / 32-47 inches
Control panel	Front panel
Cup sizes	Up to 152 mm / 6 inches
Water tank	1.8 liters/60.8 ounces - Removable type
Coffee bean hopper capacity	250 g / 1 cup
Coffee grounds drawer capacity	15
Pump pressure	15 bar
Boiler	Stainless steel type
Safety devices	Thermal fuse

WARRANTY AND SERVICE

Warranty

For detailed information on your warranty and related conditions, please read the warranty booklet supplied separately.

Service

We want to ensure that you remain satisfied with your machine. If you have not already done so, please register your purchase at **www.philips.com/welcome**. This will enable us to stay in contact with you and send you cleaning and descaling reminders.

If you need service or support, please visit the Philips website at **www.philips.com/support** or contact the Philips Saeco hotline in your country. You find its phone number in the warranty booklet by packed separately or on **www.philips.com/support**.

ORDERING MAINTENANCE PRODUCTS

For cleaning and descaling, use Saeco maintenance products only. You can purchase these at the Philips online shop at www.shop.philips.com/service, your local dealer or at authorised service centres.

If you have any difficulties obtaining maintenance products for your machine, please contact the Philips Saeco hotline in your country.

The contact details can be found in the warranty booklet by-packed separately or on www.philips.com/support.

Overview of maintenance products



- Descaling solution CA6700



- INTENZA+ water filter cartridge CA6702

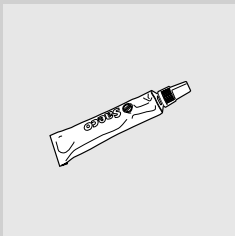

- Grease HD5061



- Maintenance kit CA 6706

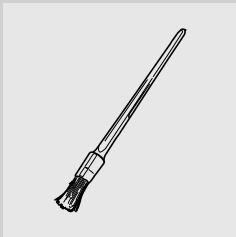

- Cleaning brush CA HD5084



The manufacturer reserves the right to make changes without prior notice.

www.philips.com/welcome



421946005761

Rev.00 del15-01-14