



PICOBARISTO
SM3061, HD8927

EN USER MANUAL

PHILIPS

Saeco, a Philips brand

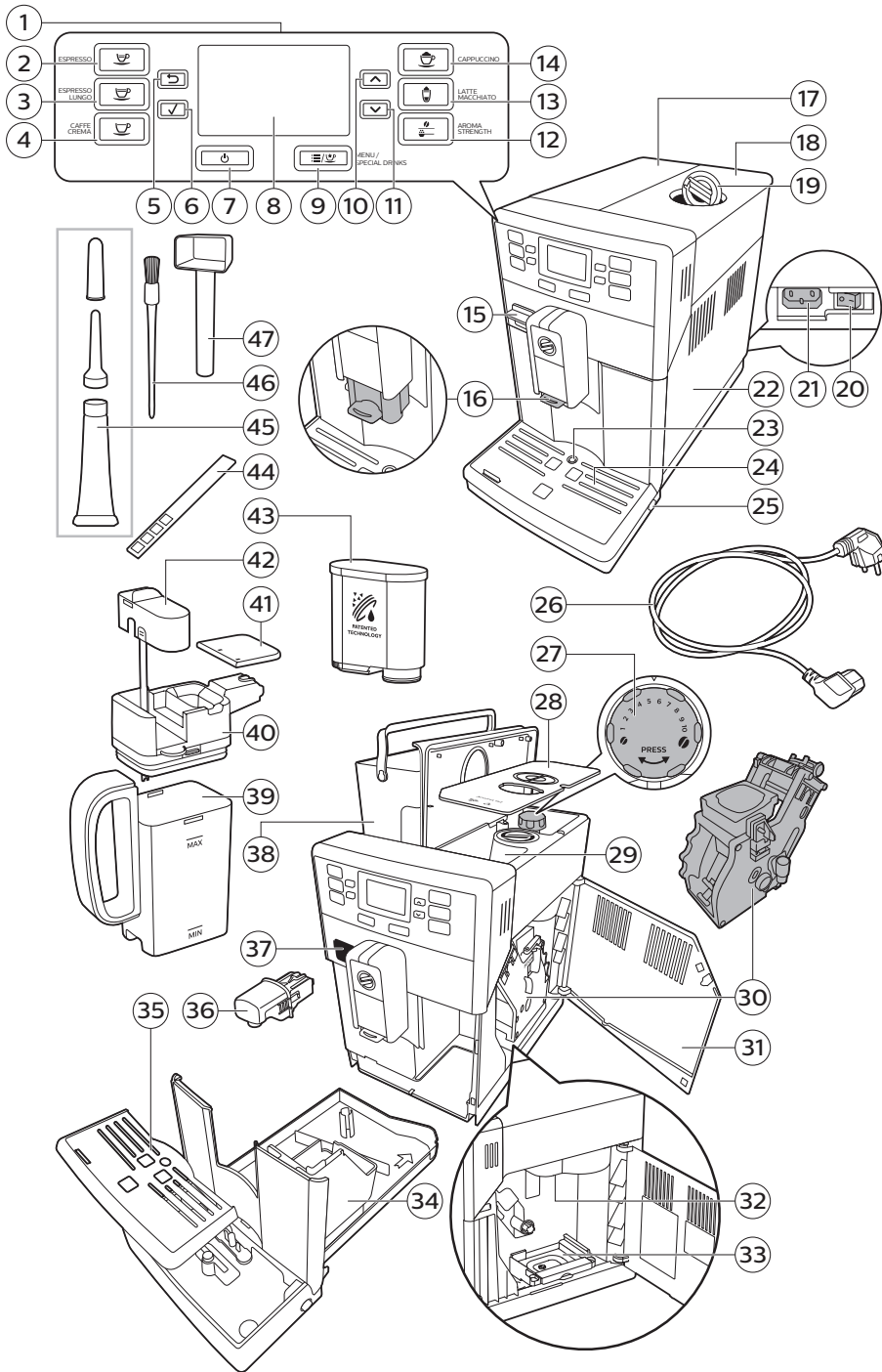

Contents

Machine overview	5
Introduction	5
First installation	6
AquaClean filter	6
Activating the AquaClean filter	6
Replacing the AquaClean filter	8
Replacing the AquaClean filter after 8 filters were used	8
Measuring the water hardness	8
Control panel and display	9
One-touch beverage buttons	9
Navigation buttons	9
MENU/SPECIAL DRINKS button	10
AROMA STRENGTH button	10
Brewing coffee	10
Brewing coffee with beans	10
Brewing coffee with pre-ground coffee	10
Special drinks and hot water	11
How to select special drinks	11
Dispensing hot water	11
Brewing milk-based coffee beverages and milk froth	11
Beverage types and lengths	12
Beverage types	12
Beverage lengths	13
Adjusting volume and taste	13
Adjusting coffee and milk volume	13
Adjusting coffee strength	14
Adjusting grinder settings	14
Cleaning and maintenance	15
Cleaning table	15
Cleaning the brew group	16
Cleaning the brew group under the tap	16
Cleaning the brew group with coffee oil remover tablets	16
Reinserting the brew group	17
Lubrication	18
Cleaning the milk carafe	18
Quick Clean function	18
Thorough cleaning of the milk carafe	19
Weekly cleaning of the milk carafe	19
Monthly cleaning of the milk carafe	20
Descaling procedure	21
What to do if the descaling procedure is interrupted	23
Warning icons and error codes	23
Meaning of the warning icons	23
Meaning of the error codes	24
Troubleshooting	24

Machine overview

1	User interface	25	Drip tray release button
2	ESPRESSO button	26	Cord
3	ESPRESSO LUNGO button	27	Grind setting knob
4	CAFFÈ CREMA button	28	Cover of bean hopper
5	Escape button	29	Bean hopper
6	OK button	30	Brew group
7	Standby button	31	Inside of service door with cleaning instructions
8	Display	32	Coffee exit duct
9	MENU/SPECIAL DRINKS button	33	Coffee residues drawer
10	UP button	34	Coffee grounds container
11	DOWN button	35	Drip tray cover
12	AROMA STRENGTH button	36	Hot water dispensing spout
13	LATTE MACCHIATO button	37	Opening for hot water dispensing spout
14	CAPPUCCINO button	38	Water tank
15	Protection cover	39	Milk container
16	Adjustable coffee dispensing spout	40	Milk dispensing unit
17	Lid of water tank	41	Lid of milk dispensing unit
18	Lid of bean hopper	42	Milk dispensing spout
19	Lid of pre-ground coffee compartment	43	AquaClean filter
20	Main switch	44	Water hardness test strip
21	Socket for cord	45	Grease tube with application tip and cap
22	Service door	46	Cleaning brush
23	'Drip tray full' indicator	47	Measuring scoop
24	Drip tray		

Introduction

Congratulations on your purchase of a Saeco full-automatic coffee machine! To fully benefit from the support that Saeco offers, please register your product at www.saeco.com/care.

To help you get the best out of your coffee machine, Saeco offers full support in 4 different ways:

- The separate quick start guide for first installation and first use.



- This user manual for more detailed information on how to use the machine, how to keep it clean, how to descale it and how to solve problems.
- This is the QR code. Scan this code to access instruction videos on how to brew the best coffees, how to clean the machine and for a list of frequently asked questions. (www.saeco.com/care)
- The separate booklet with important safety information.

First installation

For first installation, follow the instructions on the separate quick start guide.

Note: This machine has been tested with coffee. Although it has been carefully cleaned, there may be some coffee residues left. We guarantee, however, that the machine is absolutely new.

Note: You can install the AquaClean filter during the first installation procedure (see separate quick start guide). If you skip installation of the AquaClean filter at first use, you can install it later by entering the menu.

AquaClean filter

The AquaClean filter is designed to reduce limescale deposits in your coffee machine and provide filtered water to preserve the aroma and flavor of each cup of coffee. If you use a series of 8 AquaClean filters as indicated in this user manual, you don't have to descale your machine for 5000 cups.

Note: Your machine has to be completely limescale-free before you start to use the AquaClean filter. If you did not activate the filter during first installation, you need to descale the machine before you activate the filter.

Activating the AquaClean filter

Note: Always confirm activation of the AquaClean filter in the machine menu as described below. You also need to do this after replacing the AquaClean filter. By activating the AquaClean filter in the machine menu, the machine monitors the number of filters used. When the filter has been replaced 8 times, the machine reminds you to descale it.

- 1 For instructions on how to prepare the AquaClean filter for use, see the separate quick start guide.

Note: Shake the AquaClean filter for about 5 seconds, immerse it upside down in a jug with cold water and wait until no more air bubbles come out.

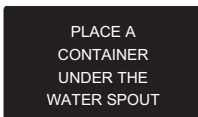
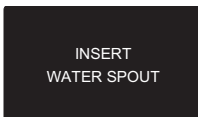
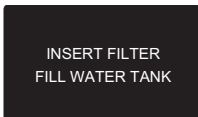
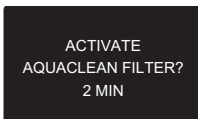

- 2 Press the MENU/SPECIAL DRINKS button, select MENU and press the OK button to confirm. Scroll to select AQUACLEAN FILTER. Press the OK button to confirm.
 - The display shows the number of AquaClean filters that have been installed previously from 0 to 8 filters.

- 3 The display asks if you want to activate the filter. Press the 'Ok' button to confirm.

- 4 The display asks you to insert the filter and fill the water tank. Make sure you fill the water tank up to the MAX level indication.

- 5 The display reminds you to insert the hot water spout into the machine. Press the OK button to confirm.

- 6 The display reminds you to place a container under the hot water spout. Press the OK button to confirm. The machine starts dispensing water.

- The filter activation screen appears with a progress bar showing the progress of filter activation.

- When activation is finished, the display shows a tick to confirm activation.



- Then the machine ready screen appears with the AquaClean 100% icon to indicate that the filter has been activated.

Replacing the AquaClean filter

Note: Replace the AquaClean filter as soon as the capacity has dropped to 0% and the filter icon flashes quickly. Replace the AquaClean filter at least every 3 months, even if the machine has not yet indicated that replacement is required.

Tip: We advise you to buy a new filter when the capacity has dropped to 10% and the filter icon starts flashing slowly. This ensures that you can replace the filter when the capacity has dropped to 0%.



- 1 Take out the AquaClean filter and replace it by a new AquaClean filter (also see the separate quick start guide).
- 2 Press the MENU/SPECIAL DRINKS button, scroll to AQUACLEAN FILTER. Press the OK button to confirm.
 - The display asks if you want to activate a new filter.
- 3 Press the OK button to confirm.
 - The display automatically updates the number of filters used.
 - Dispense 2 cups of hot water (0.5 l) to complete the activation. Discard this water.

Replacing the AquaClean filter after 8 filters were used

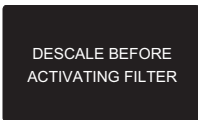

- 1 When the filter icon starts flashing on the display, press the MENU/SPECIAL DRINKS button, scroll to AQUACLEAN FILTER and press the OK button to confirm.
 - The display tells you that you need to descale the machine before activating the new filter.
- 2 Press the OK button to start the descaling procedure.
 - Press the escape button several times to leave the filter menu if you do not want to descale right away.
- 3 At the end of the descaling procedure, the display asks you if you want to install the AquaClean filter.
 - Follow the steps in 'Replacing the AquaClean filter'.

Measuring the water hardness

Note: If you have installed the AquaClean filter, you do not need to set the water hardness.

To be able to adjust the machine settings to the water in your region, please measure the water hardness with the water hardness test strip supplied. The default water hardness of the machine is set to the highest level (4). If the

measured water hardness is different, adjust the setting in the machine menu.

- 1 Immerse the water hardness test strip (supplied with the machine) in tap water for 1 second.
- 2 Remove the water hardness test strip and wait for 1 minute.
- 3 Check how many squares have turned red and check the water hardness in the table below.

number of red squares	value to be set	water hardness
■□□□	1	very soft water
■□□■	2	soft water
■□■□	3	hard water
■□■□	4	very hard water

- 4 Press the MENU button, select menu and scroll to select water hardness. Select the preferred water hardness setting and press the OK button to confirm.

Control panel and display

This espresso machine has a self-explaining display for easy use. Read the sections below for a quick explanation of the buttons.

One-touch beverage buttons

Use the one-touch beverage buttons (ESPRESSO, ESPRESSO LUNGO, CAFFÉ CREMA, CAPPUCCINO and LATTE MACCHIATO) to quickly prepare one of the preset beverages.

- Make sure that the milk carafe is in place and prepared for use when you select cappuccino or latte macchiato (see the separate quick start guide).
- Note: If you want to stop the brewing process before the machine has finished dispensing the preset coffee volume, press the OK button or the previously selected beverage button.
- You can adjust the volume of espresso or espresso lungo.
- After preparing a milk-based beverage, the machine starts the QUICK CARAFE CLEAN procedure.

Navigation buttons

Use the buttons described below to navigate through the menu:



Escape button: press this button to return to the main menu.



Up button: press this button to scroll up through the display menu.



Ok button: press this button to select, confirm or stop a function.



Down button: press this button to scroll down through the display menu.

MENU/SPECIAL DRINKS button

Use the MENU/SPECIAL DRINKS button to prepare other drinks, like hot water and frothed milk. You can also use the MENU button to change the following settings:

- Language: you can use the MENU button to set your preferred language.
- Display contrast
- Coffee temperature
- Stand-by time: this is the time after which the machine goes into standby mode.
- Water hardness: to be able to adjust the machine settings to the water in your region, please measure the water hardness.
- To activate the AquaClean filter
- To start descaling

AROMA STRENGTH button

Use the AROMA STRENGTH button to adjust the coffee strength (see 'Adjusting coffee strength') or to brew pre-ground coffee.

Brewing coffee

Brewing coffee with beans

Caution: Only use espresso beans. Never put ground coffee, unroasted coffee beans or caramelized coffee beans in the bean hopper, as this may cause damage to the machine.

To brew coffee, follow the instructions on the separate quick start guide.

To brew two cups of espresso or espresso lungo, press the button of the desired beverage twice. The machine automatically carries out two grinding cycles in sequence.

Note: Using the cover of the bean hopper helps to keep the beans fresh.

Brewing coffee with pre-ground coffee

When you brew coffee with pre-ground coffee, use the measuring scoop supplied to put the correct dose in the pre-ground coffee compartment. Do not add too much pre-ground coffee to avoid the coffee grounds drawer from getting clogged.

- 1 Open the lid of the pre-ground coffee compartment.

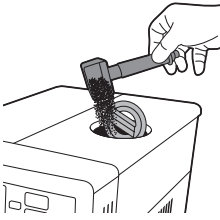

- 2 Pour **one** measuring scoop of pre-ground coffee into the pre-ground coffee compartment and close the lid.

Caution: Do not put any other substance than pre-ground coffee in the pre-ground coffee compartment, as this may damage the machine.

- 3 Place a cup under the coffee dispensing spout.
- 4 Press the AROMA STRENGTH button and select the pre-ground coffee brewing function.
- 5 Press the OK button to confirm.
The machine automatically starts brewing the selected beverage.

Note: With pre-ground coffee you can only brew one coffee at a time.

Special drinks and hot water

How to select special drinks

- 1 Press the MENU/SPECIAL DRINKS button and select DRINKS.
- 2 Press the OK button to confirm.
- 3 Scroll through the menu and select the desired beverage.

Dispensing hot water

Caution: Steam and hot water may spray out of the hot water dispensing spout when brewing starts. Wait until brewing has ended before you remove the hot water dispensing spout.

- 1 Insert the hot water dispensing spout.
- 2 Press the MENU/SPECIAL DRINKS button. Select DRINKS, confirm and scroll to select HOT WATER.

Caution: Only select HOT WATER in the menu when the hot water dispensing spout is installed.

- 3 Press the OK button to confirm. The display reminds you to install the hot water dispensing spout; press the OK button to confirm. The machine starts dispensing hot water.
- 4 To stop dispensing hot water, press the OK button.

Brewing milk-based coffee beverages and milk froth

Note: For more information on how to use the milk carafe, read the separate quick start guide or scan the QR code (see 'Introduction ') to access the dedicated website for instruction videos.

Caution: Make sure that the milk carafe is installed and the milk froth dispensing spout is open before you select a milk-based coffee beverage or milk froth. If the milk carafe is not installed correctly, steam and hot milk may spray out of the milk froth dispensing spout.

- 1 Place a cup under the open milk froth dispensing spout.
- 2 Choose your milk-based beverage.
 - Press the one-touch CAPPUCCINO or LATTE MACCHIATO button to brew one of these milk-based beverages right away.
 - Press the MENU/SPECIAL DRINKS button, choose DRINKS and scroll down through the drinks to select MILK FROTH.
 - The machine reminds you that you have to install the milk carafe and open the milk froth dispensing spout.
- 3 The machine first dispenses a preset volume of frothed milk into the cup or glass and then dispenses a preset volume of coffee.
 - To stop dispensing milk or coffee, press the OK button.
- 4 After brewing milk-based coffee beverages, the display asks you if you want to perform the quick clean procedure for the milk carafe. You have 10 seconds to activate the quick clean procedure. You can perform the quick clean procedure while leaving the milk inside the milk carafe. It is recommended to perform the quick clean procedure at least once a day. Press the OK button to confirm that you want to perform the quick clean procedure or press the escape button to perform the quick clean procedure later.

Beverage types and lengths

Beverage types

Beverage name	Description	How to select
Espresso	Coffee with thick crema served in a small cup	One-touch beverage button on control panel
Espresso lungo	A longer espresso with thick crema served in a medium-sized cup	One-touch beverage button on control panel
Ristretto	Shorter espresso with thick crema served in a small cup	MENU/SPECIAL DRINKS
Caffè crema	Long espresso with thin crema served in a large cup	MENU/SPECIAL DRINKS
Espresso double	Double espresso with thick crema served in a small cup	MENU/SPECIAL DRINKS
Cappuccino	1/3 espresso, 1/3 hot milk and 1/3 milk foam served in a large cup	One-touch beverage button on control panel
Baby cappuccino	Smaller cappuccino served in a medium-sized cup	MENU/SPECIAL DRINKS
Flat white	Coffee with hot milk topped with thin crema served in a tall glass	MENU/SPECIAL DRINKS
Latte macchiato	Long shot of hot milk with foam and a shot of espresso served in a tall glass	One-touch beverage button on control panel

Beverage name	Description	How to select
Milk froth	Hot milk with foam	MENU/SPECIAL DRINKS
Hot water		MENU/SPECIAL DRINKS

Beverage lengths

Beverage name	Standard length	Length range
Espresso	40 ml	20 - 230 ml
Ristretto	30 ml	20 - 230 ml
Espresso Lungo	80 ml	20 - 230 ml
Caffè Crema	125 ml	20 - 230 ml
Espresso Double	60 ml (double grinding)	40 - 230 ml
Hot water	300 ml	50 - 450 ml

Adjusting volume and taste

Adjusting coffee and milk volume

You can adjust the volume of the beverage brewed according to your taste and to the size of the cups.

Caution: Do not use cups that have a diameter of more than 8cm, to avoid damage to the front panel.

Note: We advise you to use glass cups or cups with a ceramic-coated rim.

- 1 To adjust the espresso volume, press and hold the ESPRESSO button until the display shows the MEMO icon.
 - The machine enters the programming phase and starts to brew the selected beverage.
- 2 Press the OK button when the cup contains the desired amount of espresso.
 - The tick on the display shows that the button is programmed: every time it is pressed, the machine brews the set espresso volume.

Note: To set the volume of espresso lungo, caffè crema, cappuccino and latte macchiato, follow the same procedure: press and hold the button of the beverage and press the OK button when the cup contains the desired amount. To adjust the volume of milk-based coffee beverages, first insert the milk carafe and save the milk volume and then save the coffee volume.

Adjusting coffee strength

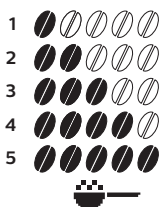

To change the coffee strength, press the AROMA STRENGTH button. Each time you press the AROMA STRENGTH button, the aroma strength changes by one degree. The display shows the chosen strength, which is only saved if you brew a coffee.

- 1 Very mild
- 2 Mild
- 3 Regular
- 4 Strong
- 5 Very strong

Note: The machine automatically dispenses the correct coffee volume for each coffee strength.

Note: You can also use the AROMA STRENGTH button to brew coffee with pre-ground coffee.

Note: After adjusting the coffee strength, the display shows the main menu again and saves the chosen aroma strength when you brew a coffee.

Adjusting grinder settings

You can adjust the grind settings by using the grind setting knob inside the bean container. At each setting selected, the ceramic coffee grinder guarantees a perfectly even grind for every cup of coffee you brew. It preserves the full coffee aroma and delivers the perfect taste to every cup.

Note: You can only adjust the grind settings when the machine is grinding coffee beans.

Caution: Do not turn the grind setting knob more than one notch at a time to prevent damage to the grinder.

- 1 Place a cup under the coffee dispensing spout.
 - 2 Open the lid of the bean hopper.
 - 3 Press the ESPRESSO button.
 - 4 When the grinder starts grinding, press down the grind setting knob and turn it to the left or right.
- There are 10 different grind settings you can choose from. The lower the setting, the stronger the coffee.

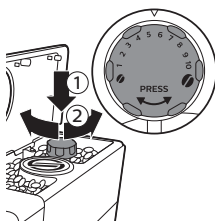

Cleaning and maintenance

Note: Consult the table below for when and how to clean all detachable parts of the machine. For more detailed information on how to clean the brew group and how to descale the machine, read the corresponding chapters below or go to the dedicated website www.saeco.com/care.

Cleaning table

Part description	When to clean	How to clean
Brew group	Weekly	Remove the brew group and clean it under the tap (see 'Cleaning the brew group under the tap').
	Depending on the type of usage	Lubricate the brew group (see 'Lubrication').
	Monthly	Clean the brew group with the coffee oil remover tablets.
Milk carafe	After every use	Perform the QUICK CARAFE CLEAN as indicated on the machine after preparing a milk-based beverage.
	Daily	Clean the milk carafe thoroughly (see 'Thorough cleaning of the milk carafe'). You can also select the QUICK CLEAN function via menu, if not already performed after preparing a milk-based beverage.
	Weekly	Disassemble the milk carafe and clean all parts under the tap (see 'Weekly cleaning of the milk carafe').
	Monthly	Use Saeco milk circuit cleaner CA6705 for this cleaning cycle (see 'Monthly cleaning of the milk carafe').
Drip tray	As soon as the red 'drip tray full' indicator pops up through the drip tray.	Empty the drip tray and clean it under the tap.
Coffee grounds container	When it suits you	Empty the coffee grounds container and clean it under the tap. Make sure the machine is switched on while you empty and clean the coffee grounds container.
Water tank	When it suits you	Clean it under the tap.

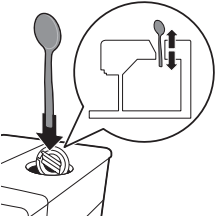
Part description	When to clean	How to clean
Pre-ground coffee compartment/coffee exit duct	Weekly	Clean the top part with a spoon handle as shown below. 

Cleaning the brew group

Note: Scan the QR code or go to www.saeco.com/care for detailed instructions on how to disassemble and clean the brew group.

Caution: Do not clean the brew group in the dishwasher and do not use washing-up liquid or a cleaning agent to clean it. This may cause the brew group to malfunction and may have a negative effect on the coffee taste.

Cleaning the brew group under the tap

- 1 Switch off the machine and unplug it.
- 2 Remove the drip tray with the coffee grounds container.
- 3 Open the service door.
- 4 Press the PUSH button (1) and pull at the grip of the brew group to remove it from the machine (2).

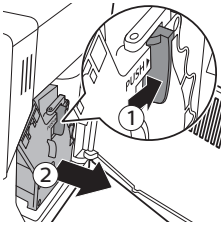

- 5 Rinse the brew group thoroughly with lukewarm water. Clean the upper filter carefully.
- 6 Let the brew group air-dry.

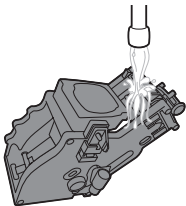

Note: Do not dry the brew group with a cloth to prevent fibers from collecting inside the brew group.

Cleaning the brew group with coffee oil remover tablets

Caution: Only use coffee oil remover tablets for cleaning. They do not have a descaling function.

- 1 Place a container under the coffee dispensing spout.
- 2 Press the AROMA STRENGTH button and select GROUND COFFEE.

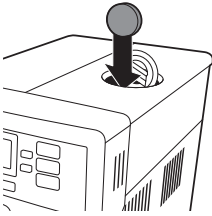

- 3 Put a coffee oil remover tablet in the pre-ground coffee compartment.
- 4 Press the CAFFÈ CREMA button. The machine dispenses water from the coffee dispensing spout.
- 5 When the progress bar has reached the middle, set the main switch on the back of the machine to OFF.
- 6 Let the degreasing solution work for approximately 15 minutes.
- 7 Set the main switch to ON. Press the standby button.
- 8 Wait until the machine performs an automatic rinsing cycle.
- 9 Perform the 'Weekly cleaning of the brew group' procedure.
- 10 Remove the drip tray with the coffee grounds container. Empty the drip tray and the coffee grounds container and place them back in the machine.
- 11 Press the AROMA STRENGTH button and select GROUND COFFEE..
- 12 Press the CAFFÈ CREMA button. The machine dispenses water from the coffee dispensing spout.
- 13 Repeat steps 12 and 13 twice. Discard the dispensed water.

Reinserting the brew group

- 1 Before you slide the brew group back into the machine, make sure the two yellow reference signs on the side match. If they do not match, perform the following step:

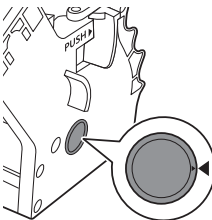

- Make sure the lever is in contact with the base of the brew group.

- 2 Make sure that the yellow locking hook of the brew group is in the correct position.

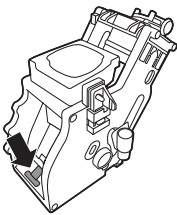

- To position the hook correctly, push it upwards until it is in uppermost position.

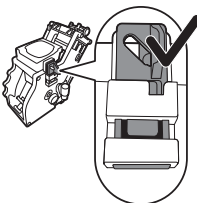

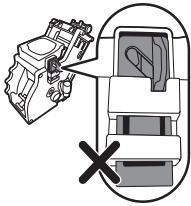

- The hook is not positioned correctly if it is still in bottommost position.
- 3 Slide the brew group back into the machine along the guiding rails on the sides until it locks into position with a click.

Caution: Do not press the PUSH button.

- 4 Close the service door.

Lubrication

For optimal performance of the machine, you have to lubricate the brew group. See table below for the lubrication frequency. For support visit our website: www.saeco.com/care.

Usage frequency	Nr of beverages brewed daily	Lubrication frequency
Low	1-5	Every 4 months
Normal	6-10	Every 2 months
Heavy	>10	Every month

- 1 Switch off the appliance and unplug it.
- 2 Remove the brew group and rinse it under a lukewarm tap (see 'Cleaning the brew group under the tap').
- 3 Apply a thin layer of grease around the shaft in the bottom of the brew group.

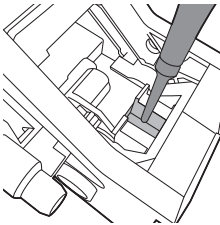

- 4 Apply a thin layer of grease to the rails on both sides (see figure).
- 5 Reinsert the brew group (see 'Reinserting the brew group').

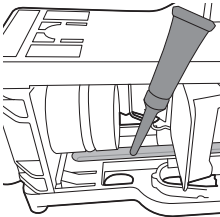

You can use the grease tube multiple times.

Cleaning the milk carafe

Quick Clean function

After preparing a milk-based beverage, the carafe cleaning icon appears on the display.

- 1 Press the MENU button and select QUICK CLEAN, press the OK button to confirm.
- 2 Make sure that the milk carafe is installed and the milk froth dispensing spout is open.

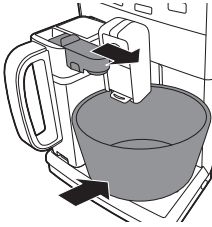

- 3 Place the container under the milk froth dispensing spout.
- 4 Press the OK button to start dispensing hot water.

Thorough cleaning of the milk carafe

To clean the milk carafe thoroughly, you have to do the following regularly:

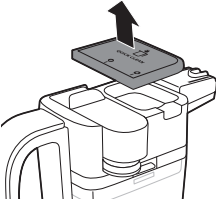

- 1 Remove the lid of the milk dispensing unit.

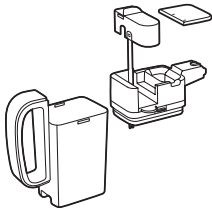

- 2 Lift the milk dispensing spout out of the milk dispensing unit.
- 3 Remove the milk tube from the milk dispensing spout.
- 4 Rinse the milk tube and milk dispensing spout with lukewarm water thoroughly.

Weekly cleaning of the milk carafe

The milk dispensing spout consists of 5 components. Disassemble all components once a week and clean them under the tap. You can also clean all components, except for the milk container, in the dishwasher.

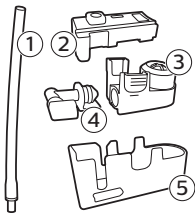

- 1 Milk tube
 - 2 Rubber support
 - 3 Milk frother
 - 4 Milk frother connector
 - 5 Housing of milk dispensing spout
- Disassembling the milk dispensing spout

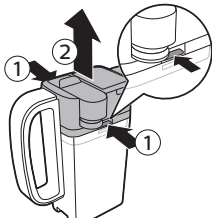

- 1 Press the release buttons on both sides of the top of the milk dispensing unit (1) and lift the top off the milk container (2).

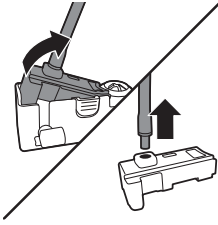

- 2 Turn the milk dispensing unit upside down and hold it firmly in your hand. Pull the milk tube off the rubber support.

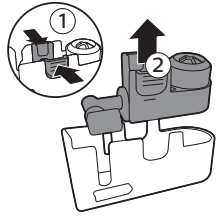

- 3 Press the release buttons on the milk frother and remove the milk frother from the the rubber support.

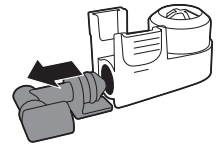

- 4 Pull the milk frother connector out of the milk frother.
- 5 Rinse all components under a lukewarm tap.

Reassembling the milk carafe

- 1 To reassemble the milk froth dispensing spout, follow steps 2 to 4 of 'Disassembling the milk froth dispensing spout' in reverse order.
- 2 Place the milk froth dispensing spout back into the top of the milk carafe.
- 3 Place the top of the milk carafe back onto the milk carafe.

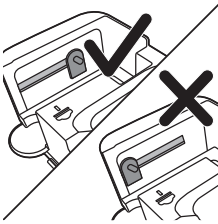

Note: Before you place the milk froth dispensing spout back into the top of the milk carafe, move the pin inside the top to the correct position. If this pin is not in the correct position, you cannot place the milk froth dispensing spout back into the top of the milk carafe.

Monthly cleaning of the milk carafe

Only use SAECO milk circuit cleaner CA6705 for this cleaning cycle.



- 1 Pour the contents of the milk circuit cleaner sachet in the milk carafe. Then fill the milk carafe with water up to the MAX level indication.
- 2 Insert the milk carafe into the machine and place a container under the milk dispensing spout.
- 3 Press the MENU button, select DRINKS and scroll to MILK FROTH. Press the OK button to start dispensing the cleaning solution.
- 4 Repeat step 3 until the milk carafe is empty.
- 5 When the carafe is empty, remove the container and the milk carafe from the machine.
- 6 Rinse the milk carafe thoroughly and fill it with fresh water up to the MAX level indication.
- 7 Insert the milk carafe into the machine.
- 8 Place the container under the milk dispensing spout.
- 9 Press the MENU button and select MILK FROTH in the DRINKS menu to start the carafe rinsing cycle.
- 10 Repeat step 9 until the milk carafe is empty.

Note: Never drink the solution dispensed during this step.

- 11 Repeat steps 6-10.
- 12 When the machine stops dispensing water, the cleaning cycle is finished.
- 13 Disassemble all the components and rinse them under a lukewarm tap. The machine is ready for use.

Descaling procedure

When the display asks 'START DESCALING?', you need to descale the machine. If you do not descale the machine when this message appears on the display, the machine will eventually stop working properly. In this case, repairs are not covered by the warranty.

Only use Saeco descaling solution to descale the machine. Saeco descaling solution is designed to ensure optimal performance of the machine. The use of other products may damage the machine and leave residues in the water. You can buy Saeco descaling solution in the online shop at www.saeco.com/care.

The descaling procedure lasts 23 minutes and consists of a descaling cycle (20 minutes) and a rinsing cycle (3 minutes). You can pause the descaling or rinsing cycle by pressing the ESC button. To continue the descaling or rinsing cycle, press the OK button.

Note: Do not remove the brew group during the descaling procedure.

Warning: Do not drink the descaling solution or the water dispensed during the descaling procedure.

- 1 Remove the drip tray and the coffee grounds container, empty and clean them and put them back into place.
- 2 Place a large container (1.5 l) under the coffee dispensing spout.

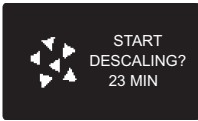

- 3 When the display asks 'Start descaling?', press the OK button to start the descaling procedure.
- 4 The display reminds you that you have to remove the AquaClean filter. Remove the filter and press the OK button.

Note: You can press the escape button to skip descaling. If you want to start the descaling procedure later, press the MENU button, select MENU and scroll to select DESCALING. Press OK to confirm.

- 5 The display reminds you that you have to empty the drip tray. Press the OK button to confirm.
- 6 The display reminds you that you have to insert the milk carafe. Fill the milk carafe with water halfway, insert the carafe and open the milk dispensing spout. Press the OK button to confirm.
- 7 Pour the descaling solution into the water tank. Fill the water tank with fresh water up to the CALC CLEAN level indication. Place the water tank back into the machine. Press the OK button to confirm.
 - The first phase of the descaling procedure starts. The machine starts dispensing the descaling solution at intervals.
 - The display shows the descaling icon, the phase indication and the duration. This first phase takes 20 minutes.

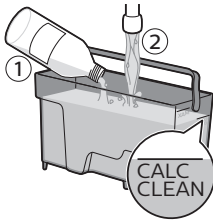

- 8 Let the machine dispense the descaling solution until the water tank is empty.
- 9 Remove the water tank and rinse it.
- 10 Fill the water tank with fresh water up to the CALC CLEAN level indication. Place the water tank back into the machine and press OK.
- 11 Remove and rinse the milk carafe. Fill the milk carafe with water up to the MIN level indication. Insert the milk carafe into the machine and open the milk froth dispensing spout.
- 12 Remove and empty the container and place it back under the coffee dispensing spout. Press OK to confirm.
- 13 The second phase of the descaling procedure starts, which is the rinsing cycle. This phase takes 3 minutes. The display shows the rinsing icon and the duration of the phase.

Note: If the water tank is not filled up to the CALC CLEAN level, the machine may require another rinsing cycle.

- 14 Wait until the machine stops dispensing water. The descaling procedure is finished when the tick appears on the display.
- 15 Press the OK button to exit the descaling cycle. The machine starts heating up and performs the automatic rinsing cycle.
- 16 Remove and empty the container.
- 17 Perform the 'Weekly cleaning of the milk carafe' procedure to clean the milk carafe after descaling.
- 18 Clean the brew group by performing the 'Weekly brew group cleaning' cycle.
- 19 Install a new AquaClean filter in the water tank.

Tip: Using the AquaClean filter reduces the need for descaling!

What to do if the descaling procedure is interrupted

Once the descaling procedure has started, you must let the machine perform the entire procedure until the very end without switching off the machine. If the machine gets stuck during descaling, you can exit the descaling procedure by pressing the standby button. If this occurs, or in case of a power failure or accidental disconnection of the cord, do the following:









- 1 Empty and rinse the water tank thoroughly.
- 2 Fill the water tank up to the CALC CLEAN level indication and switch the machine back on. The machine will heat up and perform an automatic rinsing cycle.
- 3 Before brewing any beverages, perform a manual rinsing cycle.

Note: If the descaling procedure was not completed, the machine will require another descaling procedure as soon as possible.

Warning icons and error codes

Meaning of the warning icons

The warning icons are displayed in red. Below you find a list of the warning icons that may appear on the display and their meaning.

 ADD WATER	Fill the water tank with fresh water to the MAX level indication.	 INSERT CARAFE	The milk carafe is not installed. Insert the milk carafe into the machine.
 ADD COFFEE	The bean hopper is empty. Put new coffee beans in the bean hopper.		The coffee grounds container is full. Make sure the machine is switched on. Then remove and empty the coffee grounds container.
 INSERT BREW GROUP	The brew group is not in the machine or it is not inserted correctly. Insert the brew group.		The brew group is blocked by coffee powder. Clean the brew group.
 INSERT WATER SPOUT	The hot water dispensing spout is not installed. Insert the hot water dispensing spout.		Insert the drip tray and close the service door.
 SUPPORT REQUIRED	10 If the display shows an error code, check section 'Meaning of the error codes' to see what the code on the display means and what you can do. The machine cannot be used when this icon is on the display.		

Meaning of the error codes

Below you find a list of the error codes that may appear on the display, their meaning and how to solve the problem. If these solutions do not help to remove the error code from the display and bring the machine back to normal working order, contact the Saeco hotline. Contact details can be found in the warranty booklet or on www.saeco.com/care.

Error code	Problem	Cause	Possible solution
01	The coffee grinder is blocked	The coffee exit duct is clogged.	Clean the coffee exit duct thoroughly with the handle of the measuring spoon or a spoon handle. Switch the appliance off and on again.
03 - 04	There is a problem with the brew group.	The brew group is dirty.	Remove the brew group and clean it thoroughly (see 'Cleaning the brew group').
		The brew group is not positioned correctly.	Remove the brew group and reinsert it. Make sure the two reference signs on the side match before you slide the brew group back into the machine.
05	There is a water circuit problem.	There is air in the water circuit.	Remove and place back the water tank a couple of times. Make sure you insert it into the machine properly. Check if the water tank compartment is clean.
			If you use an AquaClean filter: remove the AquaClean filter from the water tank and shake it to remove all air from the filter. Then place the AquaClean filter back into the water tank.
14	The machine is overheated.	This can have several causes.	Switch the machine off and switch it back on again after 30 minutes. Try this 2 or 3 times.

Troubleshooting

This chapter summarizes the most common problems you could encounter with the machine. If you are unable to solve the problem with the information below, visit www.saeco.com/care for a list of frequently asked questions or contact the Consumer Care Center in your country.

Problem	Cause	Solution
The machine does not switch on.	The machine is disconnected or the main switch is in the 'off' position (0).	Check if the mains cord is inserted correctly.

Problem	Cause	Solution
		Make sure the main switch is set to 'on' position (I).
The machine is in DEMO mode.	You pressed the standby button for more than 8 seconds.	Switch the machine off and then on again with the main switch on the back of the machine.
The drip tray fills up quickly.	This is normal. The machine uses water to rinse the internal circuit and brew group. Some water flows through the internal system directly into the drip tray.	Empty the drip tray when the 'drip tray full' indicator pops up through the drip tray cover.
		Place a cup under the dispensing spout to collect rinsing water.
The 'coffee grounds container full' icon remains displayed.	You emptied the coffee grounds container while the machine was switched off.	Always empty the coffee grounds container while the machine is switched on. If you empty the coffee grounds container when the machine is switched off, the coffee cycle counter is not reset. In that case, the 'empty coffee grounds container' message stays on the display even though the container is not full.
	You placed back the coffee grounds container too fast.	Do not place back the coffee grounds container until the display message prompts you to put it back.
I cannot remove the brew group.	The brew group is not in the correct position.	Close the service door. Switch the machine off and back on again. Wait for the 'machine ready' screen to appear and then remove the brew group.
	You have not removed the coffee grounds container.	Remove the coffee grounds container before you remove the brew group.
I cannot insert the brew group.	The brew group is not in the correct position.	You did not put the brew group in the correct position before placing it back. Make sure that the lever is in contact with the base of the brew group and that the hook of the brew group is in the correct position.
		Reset the machine in the following way: place the drip tray and the coffee grounds container back. Leave the brew group out. Close the service door and switch the machine on and off. Then try to reinsert the brew group.

Problem	Cause	Solution
	The machine is still in the descaling procedure.	You cannot remove the brew group when the descaling procedure is active. First complete the descaling process and then remove the brew group.
The coffee has too little crema or is watery.	The grinder is set to a too coarse setting.	Adjust the grinder to a finer setting.
	The coffee blend is not the correct one.	Change the coffee blend.
	The machine is performing its self-adjustment procedure.	Brew a few cups of coffee.
	The brew group is dirty.	Clean the brew group.
Coffee is leaking from the coffee dispensing spout.	The coffee dispensing spout is clogged.	Clean the coffee dispensing spout and its holes with a pipe cleaner.
	The coffee exit duct is clogged.	Clean the coffee exit duct.
The coffee is not hot enough.	The cups you use are cold.	Preheat the cups by rinsing them with hot water.
	The temperature is set too low. Check the menu settings.	Set the temperature to 'high' in the menu.
	You added milk.	Whether the milk you add is warm or cold, it always decreases the temperature of the coffee to some extent.
The machine grinds the coffee beans, but coffee does not come out.	The coffee exit duct is blocked.	Clean the coffee exit duct with the handle of the measuring spoon or a spoon handle. Switch the appliance off and on again.
	The grinder is set to a too fine setting.	Adjust the grinder to a coarser setting.
	The brew group is dirty.	Clean the brew group.
	The coffee dispensing spout is dirty.	Clean the coffee dispensing spout and its holes with a pipe cleaner.
The coffee comes out slowly.	The grinder is set to a too fine setting.	Use a different coffee blend or adjust the grinder.
	The brew group is dirty.	Clean the brew group.
	The coffee exit duct is blocked.	Clean the coffee exit duct with the handle of the measuring spoon or a spoon handle.
	The machine circuit is blocked by limescale.	Descale the machine.

Problem	Cause	Solution
The frothed milk is too cold.	The cups are cold.	Preheat the cups with hot water.
The milk does not froth.	The milk carafe is dirty or not inserted correctly.	Clean the carafe and make sure that you position and insert it correctly.
	The milk dispensing spout has not been opened fully.	Make sure that the milk dispensing spout is in the correct position.
	The milk carafe is incompletely assembled.	Make sure that all the components (especially the milk tube) have been assembled correctly
	The type of milk used is not suitable for frothing.	Different types of milk result in different amounts of froth and different froth qualities. We have tested the following milk types which proved to deliver a good milk froth result: semi-skimmed or full-fat cow's milk, soy milk and lactose-free milk. Other types of milk have not been tested and may result in a small amount of milk froth.
I cannot activate the AquaClean filter and the machine asks for descaling.	You have already replaced the AquaClean filter 8 times. After you have replaced the AquaClean filter 8 times, you need to descale the machine.	Descal your machine first and install the AquaClean filter. Always activate the AquaClean filter in the menu. Also do this when you replace the filter.
	The filter has not been replaced in time after the AquaClean filter icon flashed and the capacity dropped to 0%.	Descal your machine first and then install the AquaClean filter.
	You did not install the AquaClean filter during first installation, but after having brewed approx. 50 coffees (based on 100ml cups). The machine has to be completely limescale-free before you install the AquaClean filter.	First descale the machine and then install a new AquaClean filter. After descaling, the filter counter is reset to 0/8. Always confirm filter activation in the machine menu. Also do this after filter replacement.
	You did not activate the new or replaced AquaClean filter in the machine menu. Also after replacing the filter, you need to confirm activation in the machine menu.	Descal your machine first. Then activate the AquaClean filter in the menu. Also do this when you replace the filter.

Problem	Cause	Solution
The AquaClean filter icon does not appear on the display after I replaced the filter.	You did not confirm activation in the machine menu.	Confirm the activation of the filter in the machine menu. If the display shows 'START CALC CLEAN', you first need to descale the machine. Remove the AquaClean filter before descaling and reinsert it afterwards.
The AquaClean filter is installed, but the descaling message appears.	You have not activated the AquaClean filter in the machine menu.	First descale the machine and then install a new AquaClean filter. This will reset the filter counter to 0/8. Always confirm filter activation in the machine menu, also after filter replacement.
The AquaClean filter does not fit.	You need to remove air from the filter.	Let air bubbles come out of the filter.
	There is still water in the water tank.	Empty the water tank before you install the filter.
	You are trying to install another filter than the AquaClean filter.	Only the AquaClean filter fits into the machine.
	The rubber o-ring is not attached to the AquaClean filter.	Check the packaging for the o-ring and attach it to the AquaClean filter.
There is water under the machine.	The drip tray is too full and has overflowed.	Empty the drip tray when the 'drip tray full' indicator pops up through the drip tray. Always empty the drip tray before you start descaling the machine.
	The machine is not placed on a horizontal surface.	Place the machine on a horizontal surface so that the 'drip tray full' indicator works properly.

4219.460.3609.2 (11/2016)

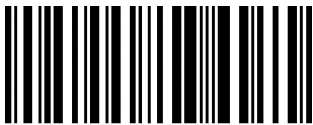

421946036092



>75% recycled paper
>75% papier recyclé

www.saeco.com/care