

PHILIPS

juice extractor

serving pitcher



HR2828



PHILIPS

IMPORTANT SAFEGUARDS

When using electrical appliances, basic safety precautions should always be followed including the following:

Read all instructions before using.

1. To protect against electrical shock, do not immerse cord, plug, or Juice Extractor in water or other liquid.
2. Close supervision is necessary when any appliance is used by or near children or invalids. Never leave an appliance unattended when in use.
3. Unplug from outlet when not in use, putting on or taking off parts and before cleaning. To unplug, grasp plug and pull straight out from outlet. Never pull cord.
4. Avoid contacting moving parts. Keep fingers or objects other than food out of the food chute.
5. Do not operate this appliance with a damaged cord or plug, or after the appliance malfunctions, or has been damaged in any manner; return the Juice Extractor to the retail location where it was purchased for examination, repair, or adjustment.
6. Use this appliance only for its intended use as described in this manual. Do not use accessories or attachments not recommended by Philips Electronics North America Corporation as they may cause fire, electric shock or injury.
7. Do not use outdoors or operate where oxygen is being administered or in the presence of explosive and/or flammable fumes.
8. Do not let cord hang over edge of table or counter, or touch hot surfaces-including the stove.
9. This appliance is intended for household use ONLY; it is not for commercial or industrial use.

10. Any service of the Juice Extractor should be performed by the retail location where it was purchased.
11. To disconnect the appliance, press the "ON/OFF" switch to OFF(O), then grasp plug body and remove plug from electrical outlet. Never yank or twist cord to unplug.
- 12. Always make sure Juice Extractor cover is clamped and locked securely in place before motor is turned on. Do not open lid while Juice Extractor is in operation.**
- 13. Be sure to turn switch to OFF (O) position after each use of the Juice Extractor. Make sure the motor stops and the sieve stops rotating completely before putting on or taking off parts or disassembling.**
- 14. Do not put your fingers or other objects into the Juice Extractor opening while it is in operation.** If food becomes lodged in opening, use food pusher or another piece of fruit or vegetable to push it down. When this method is not possible, turn motor off (O), wait until sieve stops rotating completely and unplug before disassembling Juice Extractor to remove the blockage.
15. Check the sieve after each use. If sieve becomes cracked or damaged, do not continue to use the appliance. Shredders on bottom of sieve are sharp, handle carefully.
16. Do not operate or place any part of this appliance on or near any hot surfaces such as gas or electric burner or in a heated oven.

SAVE THESE INSTRUCTIONS

SPECIAL INSTRUCTIONS

The Juice Extractor has a short cord to reduce the hazards of becoming entangled in or tripping over a longer cord. An extension cord may be used if the rating is equal to or greater than the rating of the Juice Extractor. Use an extension cord rated 13 amperes or greater. Care must be taken to arrange extension cord so that it will not drape over countertop or tabletop where it can be pulled on by children or tripped over unintentionally.

Operating the Juice Extractor and another appliance at the same time from the same electrical circuit could cause an electrical overload condition, which would blow the fuse or trip the circuit breaker.

SPECIAL POLARIZED PLUG INSTRUCTIONS

This Philips Juice Extractor has a polarized plug (one blade is wider than the other). To reduce the risk of electric shock:

- Plug will fit into polarized outlet only one way.
- If plug does not properly fit outlet at first, reverse it.
- If plug still does not fit, contact a qualified electrician.

**DO NOT ATTEMPT TO DEFEAT
THIS SAFETY FEATURE**

Table of Contents

Features	2
Preparing the Appliance for Use	3
Ingredients and Tips	4
Using the Juice Extractor	4-5
Cleaning	5-6
For Assistance	7
Warranty	Back Cover

Features

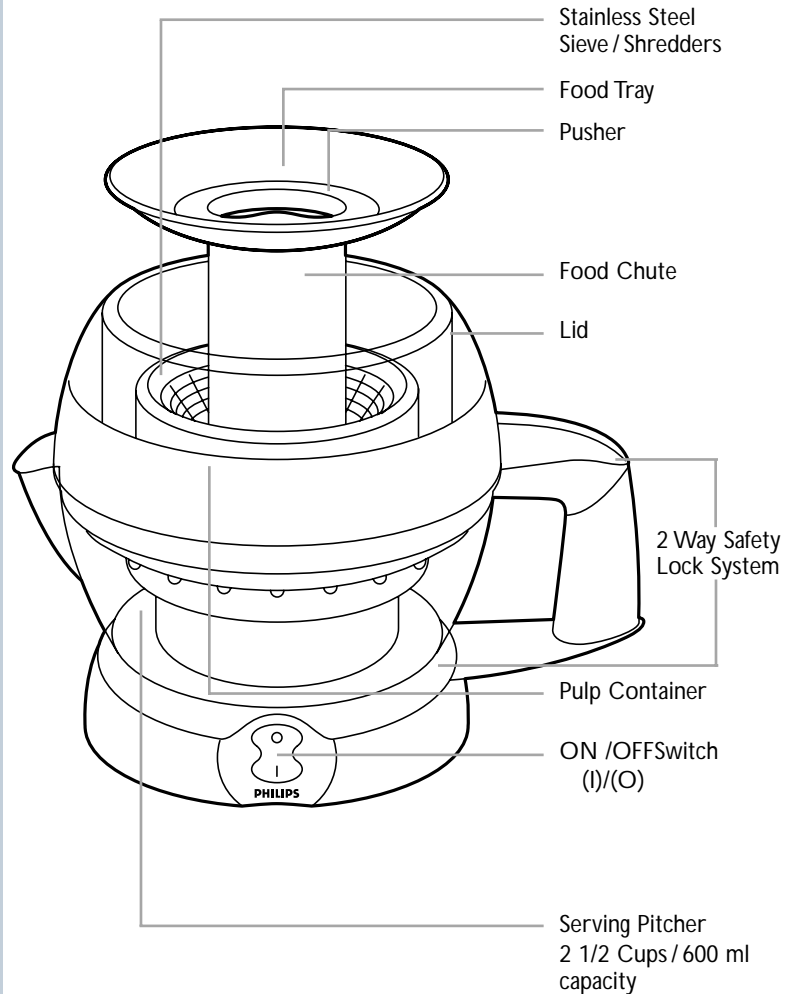

- Cord Storage
- 2 Way Safety Lock System: Both serving pitcher and pulp container cover must be locked into their respective positions before unit will operate.

Preparing the Appliance for Use

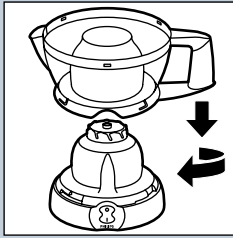

- 1 Put the serving pitcher in place on motor unit and turn the handle in the direction of the arrow until the serving pitcher will not go any further and locks into place. For safety, the Juice Extractor will not operate unless the serving pitcher and lid are securely locked into position.

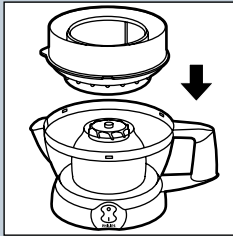

- 2 Put the pulp container on the serving pitcher. Make sure that the recesses of the pulp container cover the projections on the serving pitcher.

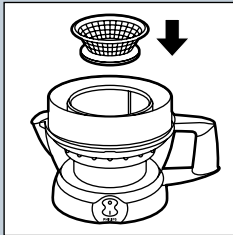

- 3 Place the sieve in the middle of the pulp container.

2 Way Safety
Lock System

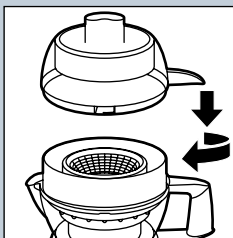

- 4 Put the lid on the pitcher and turn it in the direction of the arrow until it will not go any further and locks into place. The projection of the lid now covers the handle of the serving pitcher.

NOTE: For safety, the Juice Extractor will not operate unless the serving pitcher and lid are securely locked in position.

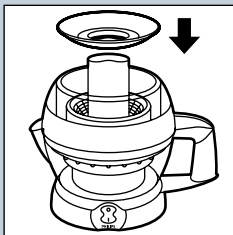

- 5 Put the food tray on the lid.
- 6 Plug the Juice Extractor into a 120V AC electrical outlet.

Ingredients and Tips

- Use fresh fruit and vegetables as they contain more juice. Pineapples, beet roots, celery stalks, apples, cucumbers, carrots, spinach, melons, tomatoes, oranges and grapes are particularly suitable for processing in the Juice Extractor.
- You don't have to remove thin peels or skins. Only thick peels, e.g. those of oranges, pineapples and uncooked beet roots need to be removed before processing. Peel any waxed fruit or vegetable. Also remove the white pith of citrus fruits because it has a bitter taste. Trim away any bruised or discolored parts.
- When preparing apple juice, remember that the thickness of the apple juice depends on the kind of apple you are using. Some kinds of apples are more juicy, while others produce a thicker juice. Choose a kind of apple that produces the type of juice you prefer.
- Apple juice turns brown very quickly. You can slow down this process by adding a few drops of lemon juice.
- Fruits that contain starch, such as bananas, papayas, avocados, figs and mangoes are not suitable for processing in the Juice Extractor. Use a food processor, blender or bar blender to process these fruits.
- Leaves and leaf stalks of lettuce can also be processed in the Juice Extractor. Leafy greens or sprouts should be rolled into tight, compact balls before putting in chute.
- Drink the juice immediately after you have extracted it. If it is exposed to air for some time, the juice will lose some of its taste and nutritional value.
- Remove large hard pits, seeds and stones from fruits (cherries, peaches, pears, etc.) or vegetables before processing.

Using the Juice Extractor

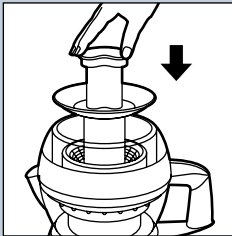

- 1** Wash the fruit and/or vegetables, remove hard pits, and cut them into pieces that will fit into the food chute.
- 2** Turn the appliance on by pressing the ON/OFF (I) switch. The appliance will only function if the serving pitcher and the lid have been properly mounted onto the motor unit and securely locked into position.
- 3** Put the food pieces in the food chute and press them gently down using the pusher. Do not exert too much pressure on the pusher; this could affect the quality of the end result and it could even cause the sieve to come to a halt.

NEVER PUT YOUR FINGERS OR AN OBJECT IN THE FOOD CHUTE.

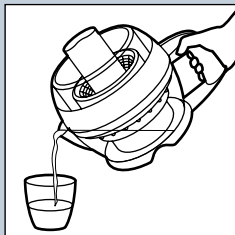

- 4** When the flow of juice into the pitcher has stopped, turn the appliance off by pressing the on/off (O) switch and **WAIT UNTIL THE SIEVE HAS COMPLETELY STOPPED ROTATING.**

Do not fill the pitcher beyond the MAX indication to prevent juice from being spilt. If you want to extract a large quantity of juice, empty the reservoir at a certain point during the process.

Do not let the appliance run continuously for more than two minutes. If you have not finished extracting juice, turn the appliance off by pressing the on/off (O) switch and allow it to cool down for two minutes before you continue.

- 5** If the pulp container becomes full before you are finished, turn the Juice Extractor off (O) and follow the directions below to empty it.

- 6** Pour out the juice.

It is not necessary to disassemble the Juice Extractor.

If the pulp container is full:

- 1** Turn the appliance off by pressing the on/off (O) switch and **WAIT UNTIL THE SIEVE HAS STOPPED ROTATING COMPLETELY.**
- 2** Empty the pulp container.
- 3** Reassemble the Juice Extractor and continue.

Cleaning

- Turn the appliance off by pressing on/off switch off (O) and unplug the cord from the electrical outlet and **WAIT UNTIL SIEVE HAS COMPLETELY STOPPED ROTATING** before you start cleaning the appliance or removing parts.
- Do not use abrasive cleansers, scourers, wire wool, acetone, alcohol, etc. to clean parts.

- 1** Remove the parts from the motor unit.
- 2** Clean the parts that have been in contact with food in hot soapy water immediately after use and rinse them with hot water. Dry all parts.

Do not put any of the parts in the dishwasher.

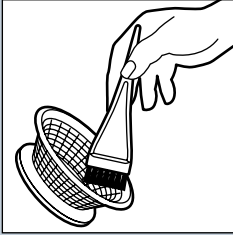

3 To clean the sieve, use a soft brush. Be careful of the sharp shredders located on the bottom of the sieve. Do not use a metal brush. Allow sieve to air dry thoroughly.

4 Clean the motor unit with a damp cloth.

Never immerse the motor unit in water or rinse it under the tap.

5 When storing the Juice Extractor, do not place the serving pitcher on the base unit in the locked position.

NOTE: Over time, parts may discolor especially from juicing carrots and tomatoes.

For assistance

For assistance call toll free:

1-800-243-7884
or visit our website: www.philipsonline.com.

FULL ONE YEAR WARRANTY

Philips Electronics North America Corporation warrants each new Philips product, model HR2828 (except cord), against defects in materials or workmanship for a period of one year from the date of purchase.

IMPORTANT: This warranty does not cover damage resulting from accident, misuse or abuse, lack of reasonable care, the affixing of any attachment not provided with the product or loss of parts or subjecting the product to any but the specified voltage.*

**PHILIPS ELECTRONICS NORTH AMERICA CORPORATION
WILL NOT PAY FOR UNAUTHORIZED SERVICE OF ANY
TYPE.**

**NO RESPONSIBILITY IS ASSUMED FOR ANY SPECIAL,
INCIDENTAL OR CONSEQUENTIAL DAMAGES.**

In order to address warranty issues, simply take or ship the product back to the retail location where it was purchased.

* Read enclosed instructions carefully.

Manufactured for:
Norelco Consumer Products Company
A Division of Philips Electronics North America Corporation
1010 Washington Blvd., Stamford, CT 06912-0015

For Assistance call 1-800-243-7884

MADE IN CHINA.



This symbol on the product's nameplate means
it is listed by Underwriters' Laboratories, Inc.

PHILIPS and Philips Shield are Registered Trademarks of Koninklijke
Philips Electronics N.V.

© 2000 Philips Electronics North America Corporation.
All Rights Reserved.

HR2828

4222.002.3146.1