

EN Welcome, Get started! ES-MX Bienvenido, ¡empieza! FR-CA Bienvenue, commencez!

EN Registration and Benefits ES-MX Registro y beneficios FR-CA Inscription et avantages

EN Digital manual ES-MX Manual digital FR-CA Manuel numérique

5

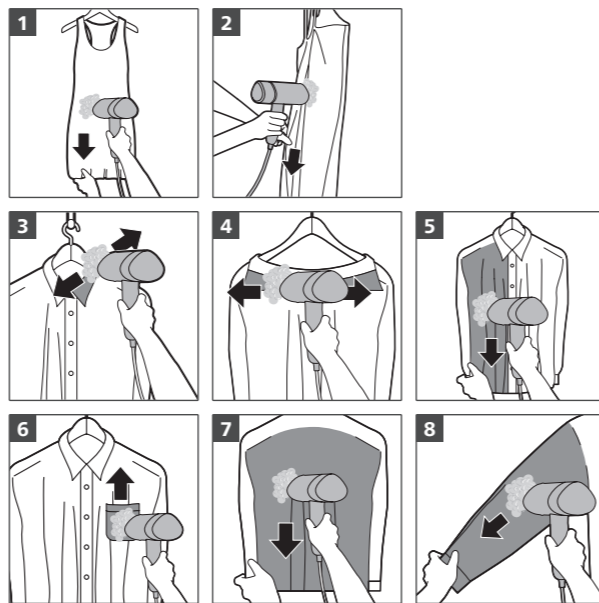

6

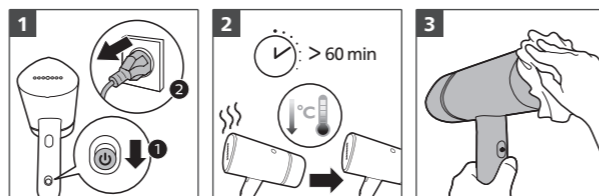

6

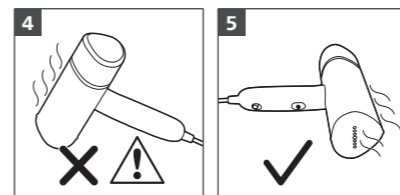

7

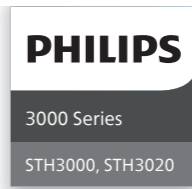
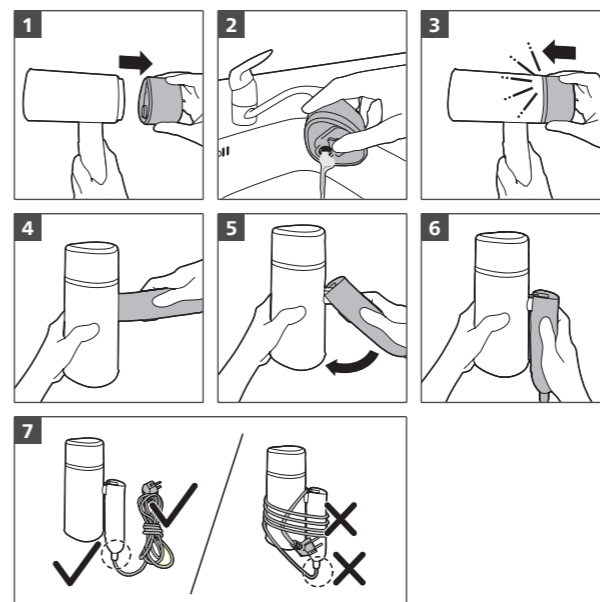

Registration and Benefits

Digital manual



PHILIPS and the Philips Shield Emblem are registered trademarks of Koninklijke Philips N.V. and are used under license. This product has been manufactured by and is sold under the responsibility of Versuni Holding B.V., and Versuni Holding B.V. is the warrantor in relation to this product. 2024 © Versuni Holding B.V. 642001017041 (26/06/2024)



1

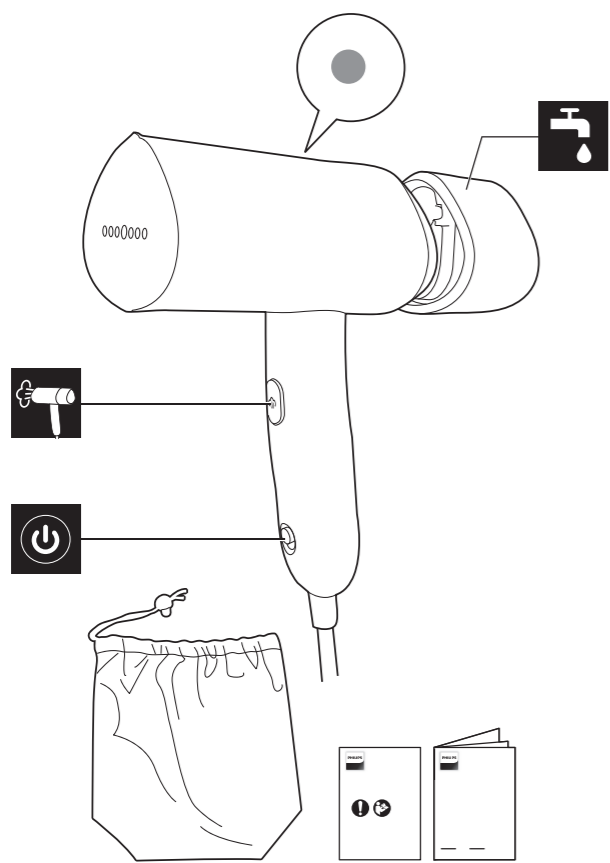

STH3010, STH3014  
STH3020, STH3024

2

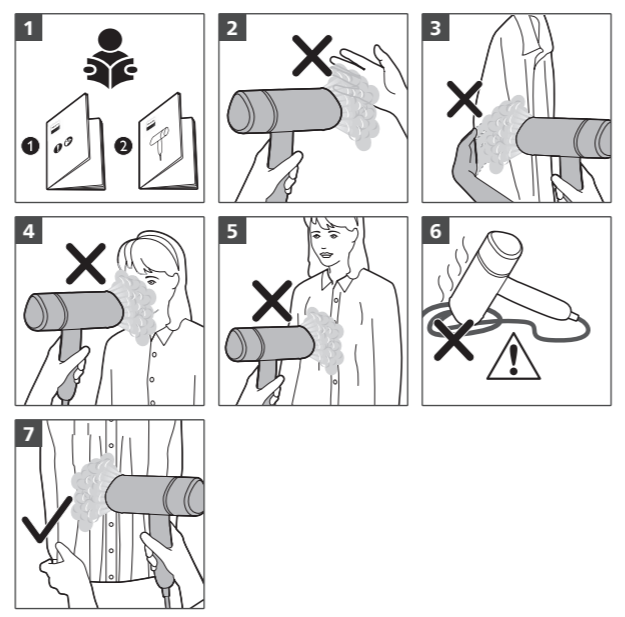

3

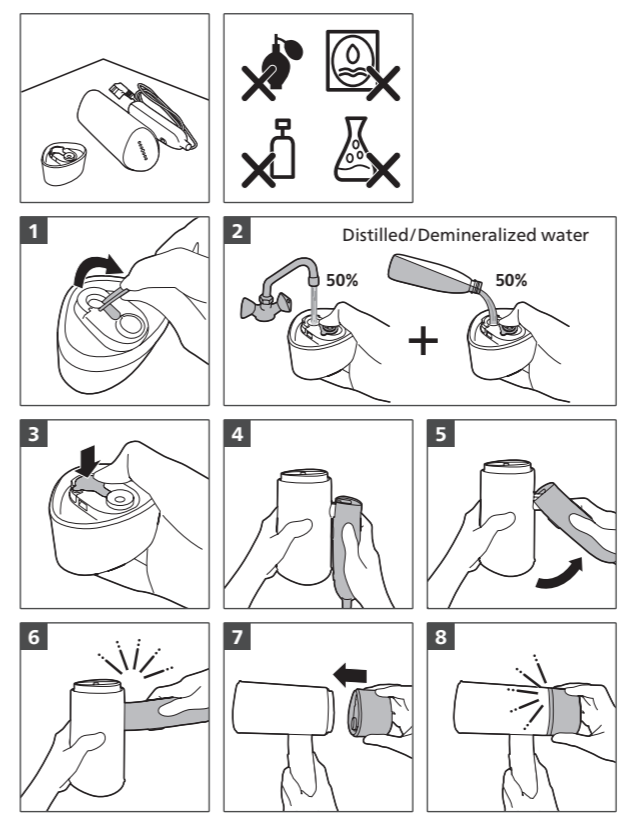

4

