

User manual



Important safety information

Read this important information carefully before you use the appliance and save it for future reference.

Danger

- Do not spray any flammable materials such as insecticides or fragrance around the appliance.
- Do not clean the appliance with water, any other liquid, or a (flammable) detergent to avoid electric shock and/or a fire hazard.
- The water in the water tank is not suitable for drinking. Do not drink this water and do not use it to feed animals or to water plants. When you empty the water tank, pour the water down the drain.

Warning

- Check if the voltage indicated on the appliance corresponds to the local mains voltage before you connect the appliance.
- If the supply cord is damaged, you must have it replaced by Philips, a service center authorized by Philips, or similarly qualified persons in order to avoid a hazard.
- Do not use the appliance if the plug, the power cord, or the appliance itself is damaged.
- This appliance can be used by children aged from 8 years and above and persons with reduced physical, sensory or mental capabilities or lack of experience and knowledge if they have been given supervision or instruction concerning use of the appliance in a safe way and understand the hazards involved. Children shall not play with the appliance. Cleaning and user maintenance shall not be made by children without supervision.
- Do not insert your fingers or objects into the air outlet or the air inlet to prevent physical injury or malfunctioning of the appliance.
- Make sure that foreign objects do not fall into the appliance through the air outlet.

Caution

- The appliance is only intended for household use under normal operating conditions.
- Always place and use the appliance on a dry, stable, flat and horizontal surface.
- Do not block the air inlet and outlet.
- Do not place anything on top of the appliance and do not sit or stand on the appliance.
- Only use the original Philips filter specially intended for this appliance. Do not use any other filter.
- Do not fill water from the air outlets on top of the appliance.



In dry conditions moisture from the humidifier will be absorbed by walls, furniture, and other items in your room. Ventilation of dry outside air will also increase the time it takes to reach the target humidity.

To optimize humidification performance, it's recommended to close doors and windows during use.

- Only fill the water tank with cold tap water. Do not use ground water or hot water.
- Do not put any substance other than water in the water tank. Do not add fragrance or chemical substance into the water. Use only water (tap, purified, mineral, any sort of potable water).
- Avoid knocking against the appliance (the air inlet and outlet in particular) with hard objects.
- Do not use the appliance near gas appliances, heating devices or fireplaces.
- Do not place the appliance directly below an air conditioner to prevent condensation from dripping onto the appliance.
- Do not use this appliance when you have used indoor smoke-type insect repellents or in places with oily residues, burning incense, or chemical fumes.
- Do not use the appliance in wet surroundings or in surroundings with high ambient temperatures, such as the bathroom, toilet, or kitchen, or in a room with major temperature changes.
- Always unplug the appliance when you want to move, clean appliance, fill the water, replace the filter or carry out maintenance.
- Do not wash the filter in a washing machine or dish washer, otherwise the filter will be deformed.
- When the appliance is not used for a long time, bacteria and mold may grow on the filter. Clean the water tank and dry the humidification filter. Check the filter before you start using the appliance again. If the filter is very dirty with dark spots, replace it.

Electromagnetic fields (EMF)

This Philips appliance complies with all applicable standards and regulations regarding exposure to electromagnetic fields.

Recycling

Do not throw away the product with the normal household waste at the end of its life, but hand it in at an official collection point for recycling. By doing this, you help to preserve the environment.

Follow your country's rules for the separate collection of electrical and electronic products. Correct disposal helps prevent negative consequences for the environment and human health.

Guarantee and service

If you need information or support, please visit www.philips.com/support or read the separate worldwide guarantee leaflet.



Order parts or accessories

If you have to replace a part or want to purchase an additional part, go to your Philips dealer or visit www.philips.com/support.

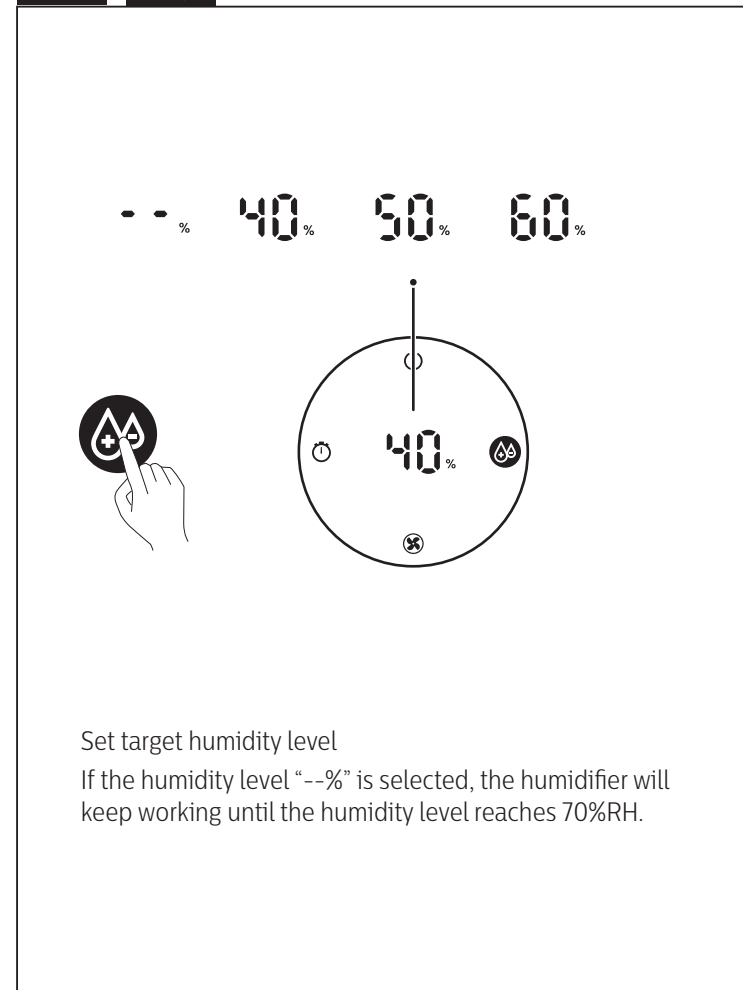
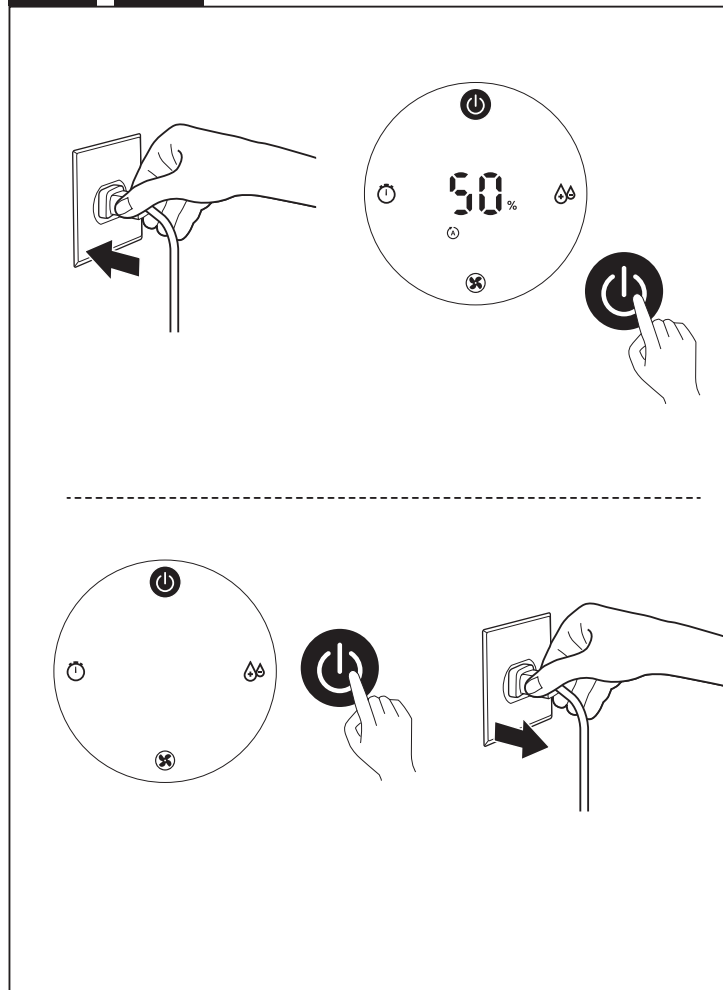
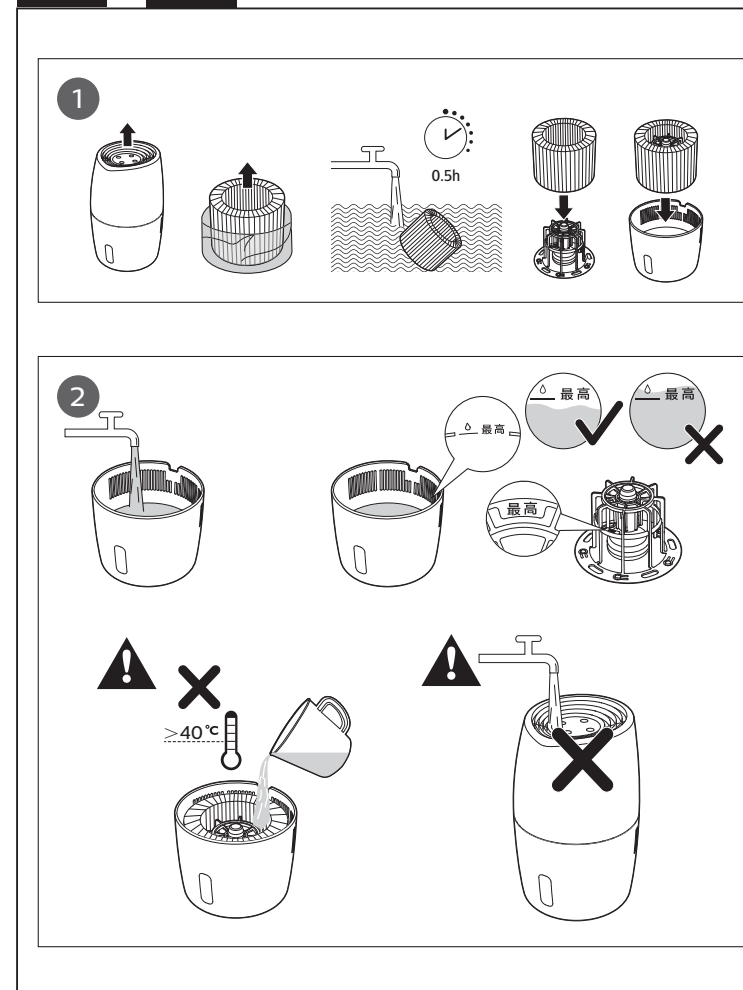
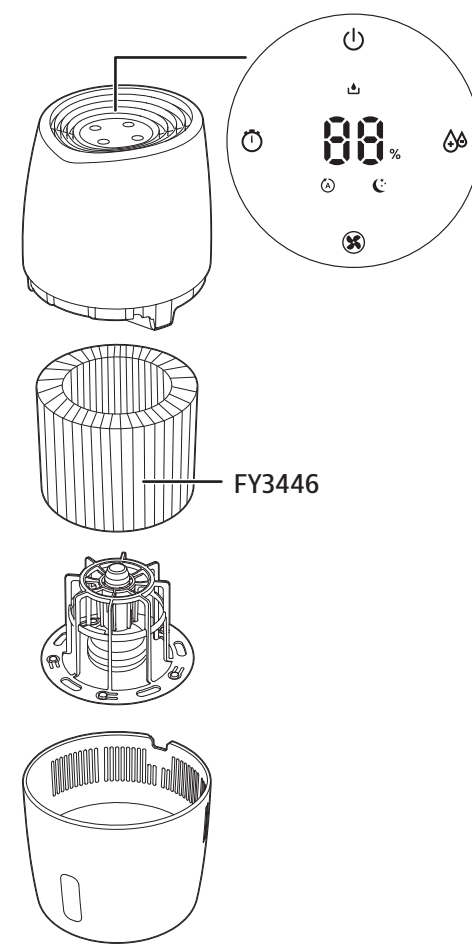
If you have problems obtaining the parts, please contact the Philips Consumer Care Center in your country (you will find its phone number in the worldwide guarantee leaflet).

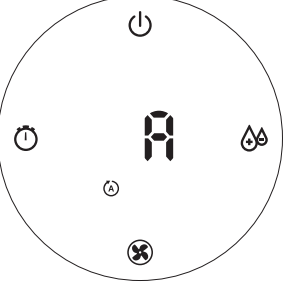
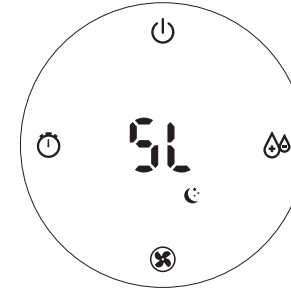
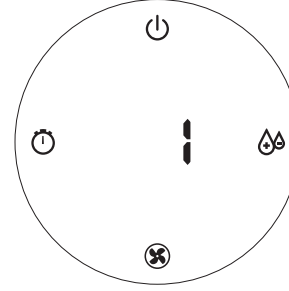
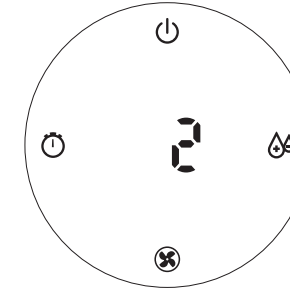
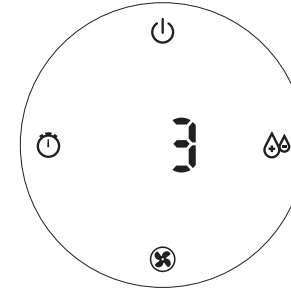

2 

				
Auto	Sleep	Manual		
				

2  Set the timer

-- 1h 2h 3h 4h 5h 6h 7h 8h 9h

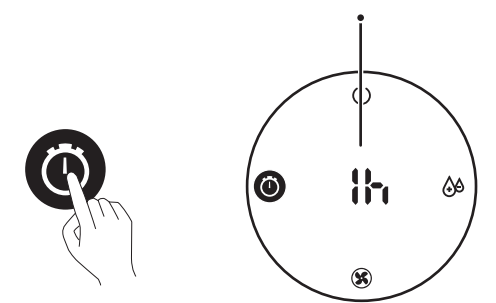

3 

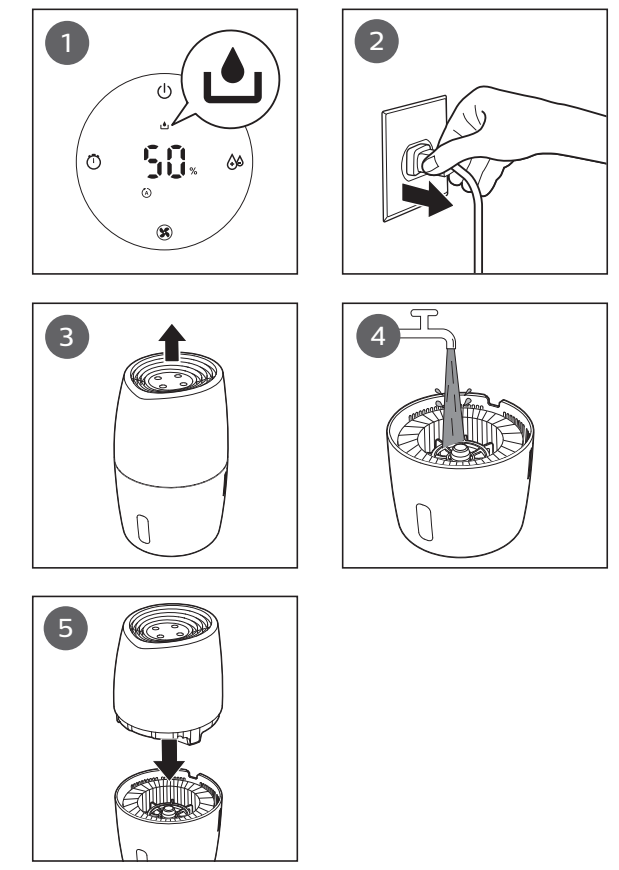

4  

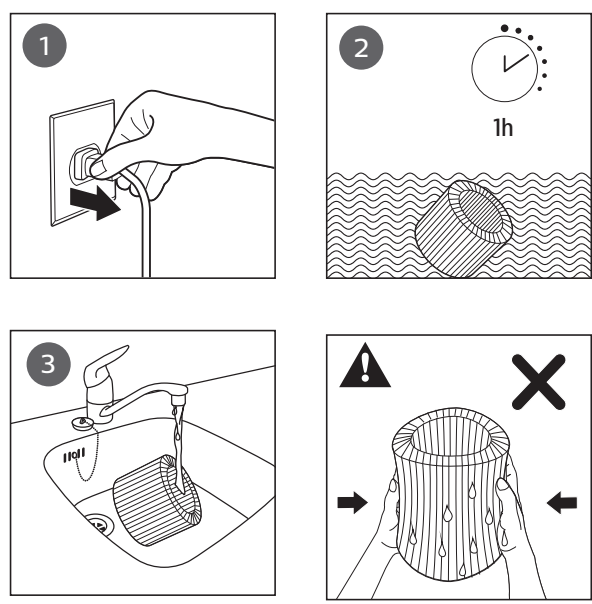

Clean the humidification filter every week.
Please soak the humidification filter with mid or acid cleanser (24g citric acid with 4L water) for 1 hour.

5  

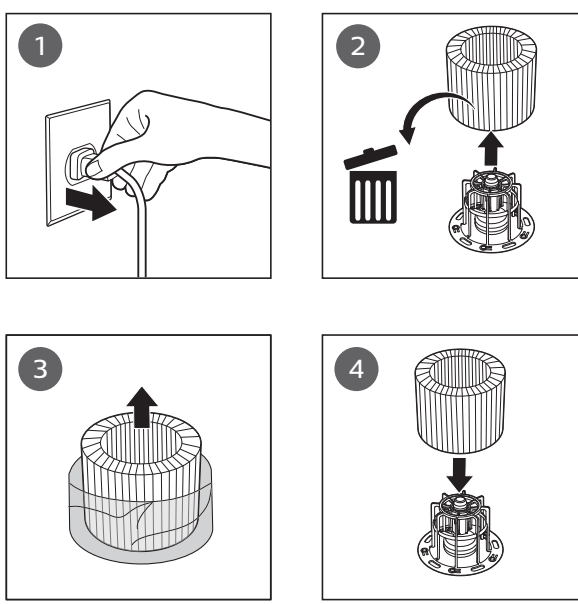

Replace the humidification filter every 6 months.
The humidification filter contains a biocidal product (Active substance Zinc pyrithione CAS 13463-41-7).