

# PHILIPS

Wet & Dry Vacuum

6000 & 7000 Series

XW6264, XW7263,  
XW7264



Welcome,  
**Get started!**



[home.id/welcome](https://home.id/welcome)



Registration  
and Benefits



Quick start



Digital manual

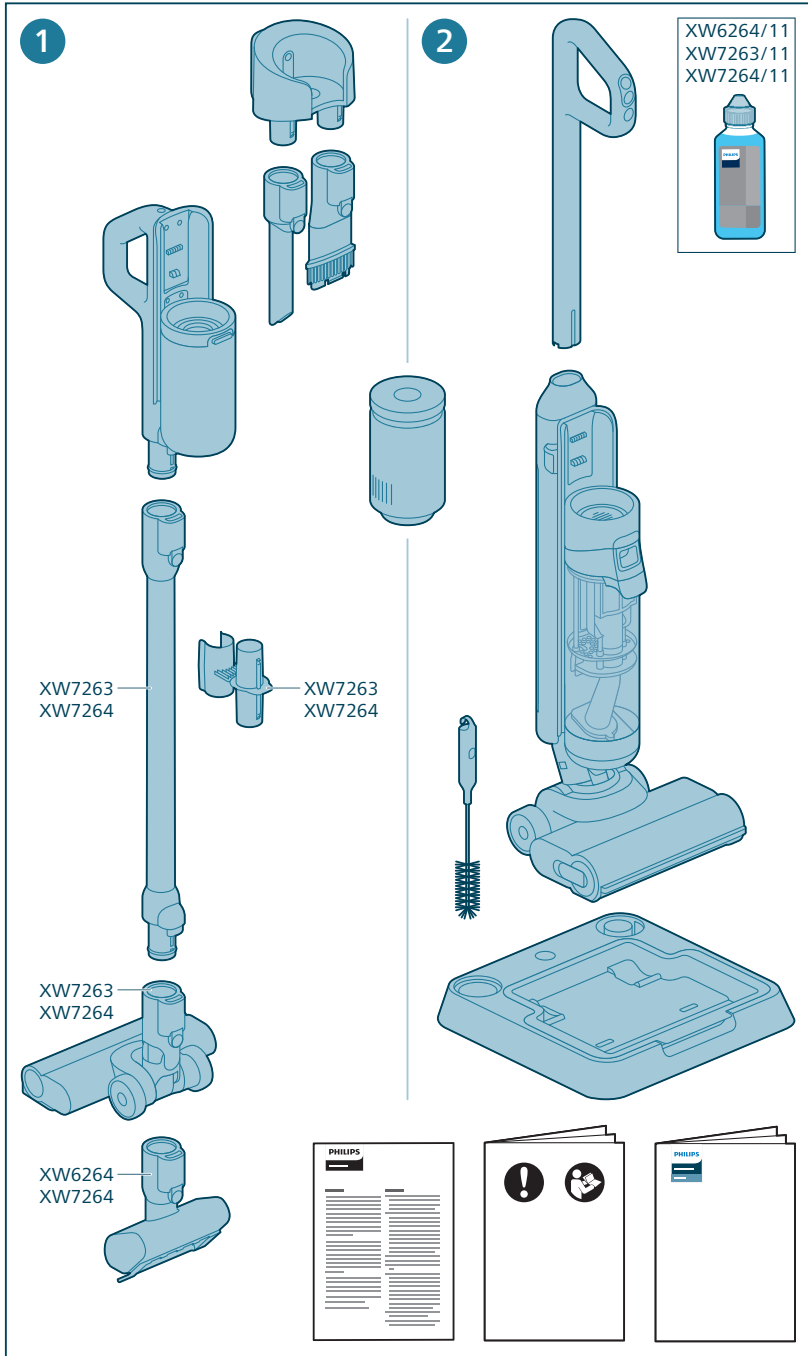

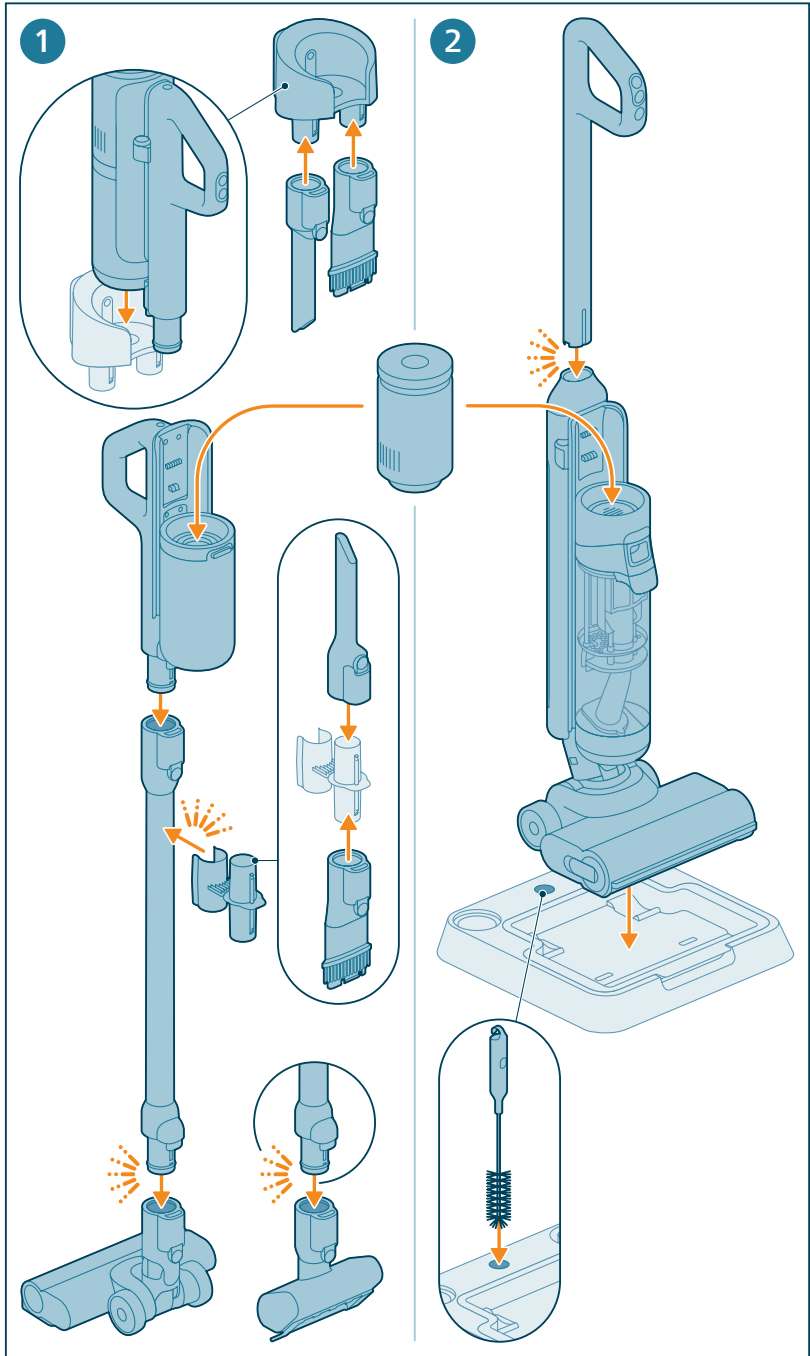

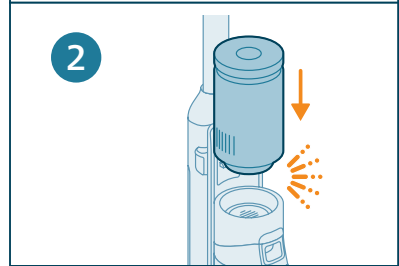
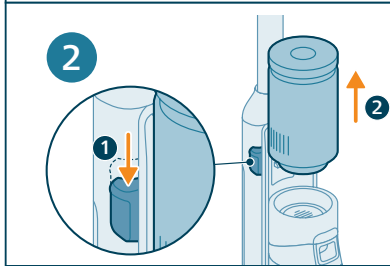
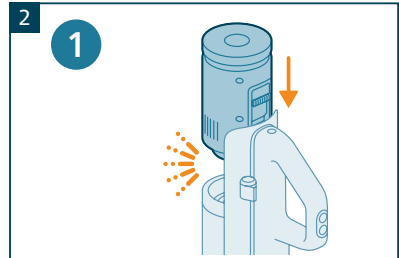
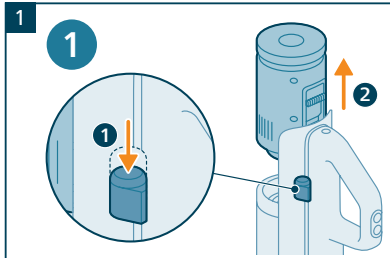

1

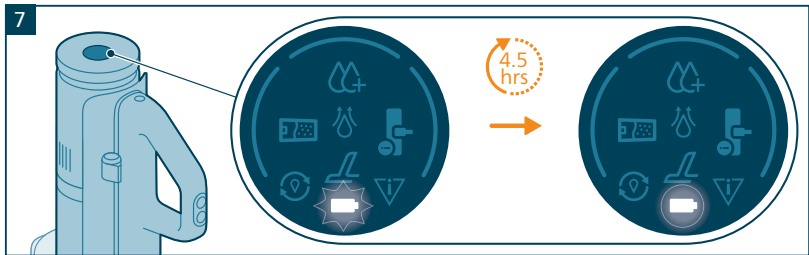
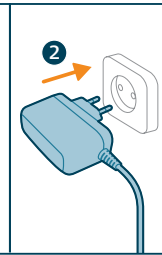
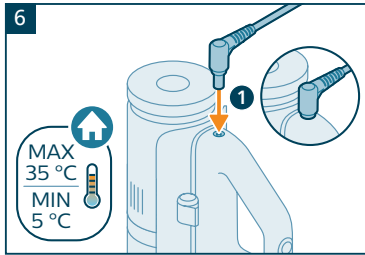
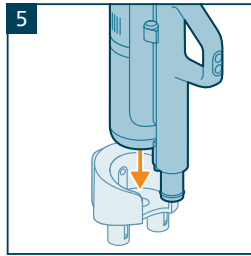
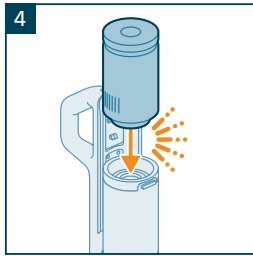
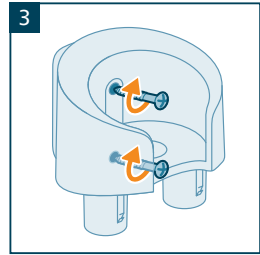
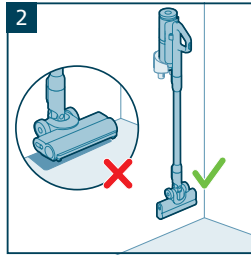
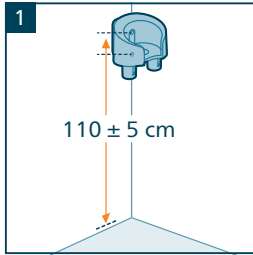

1

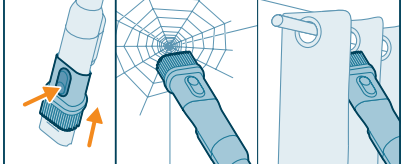
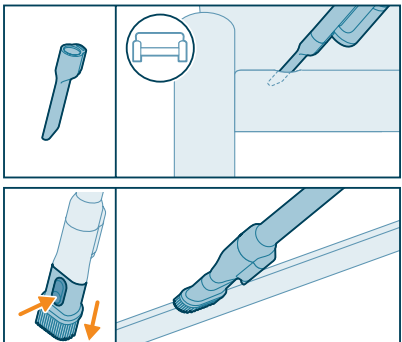
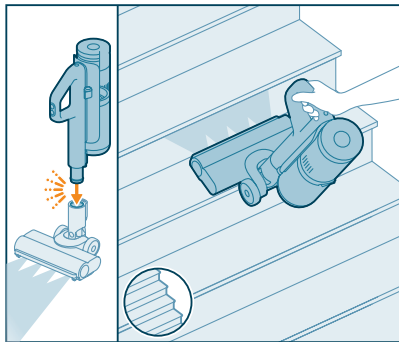
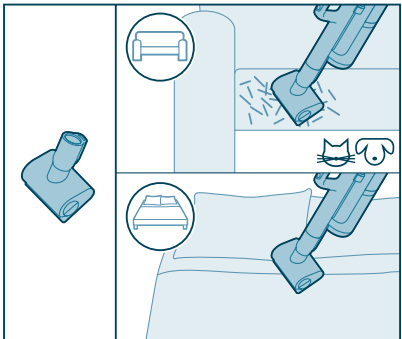
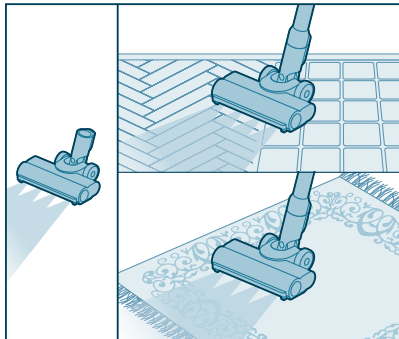
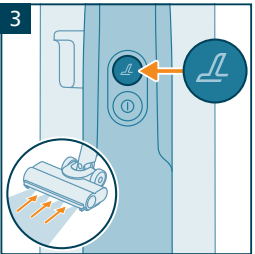
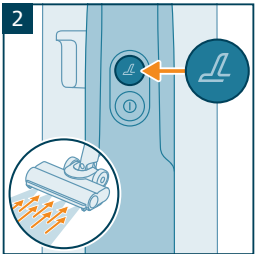
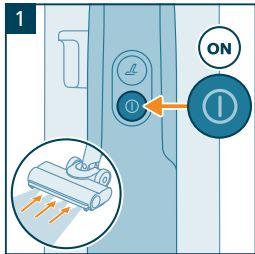

# 1

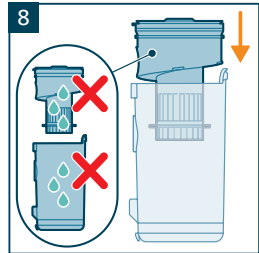
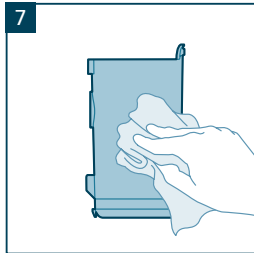
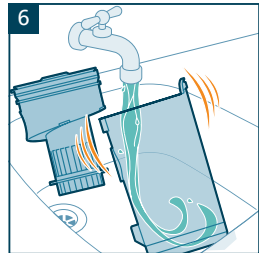
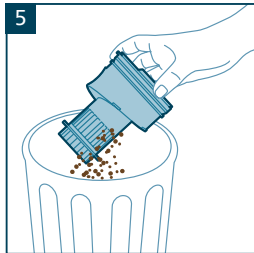
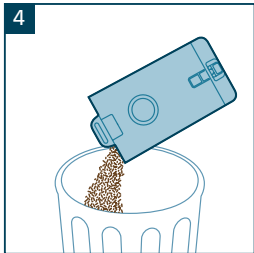
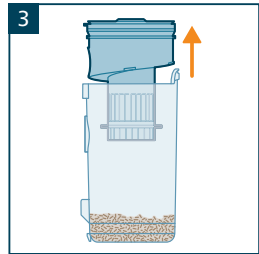
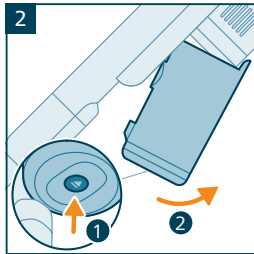
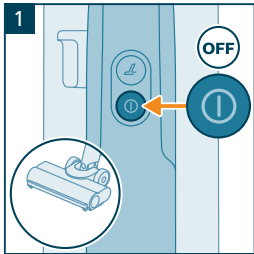
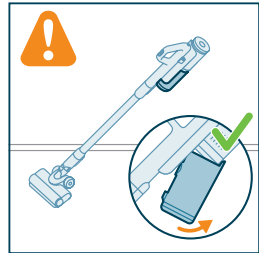
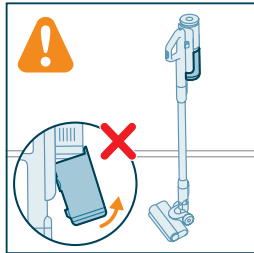
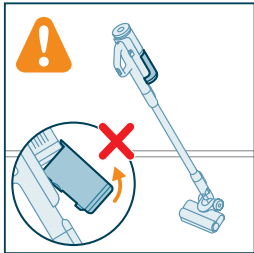

# 1

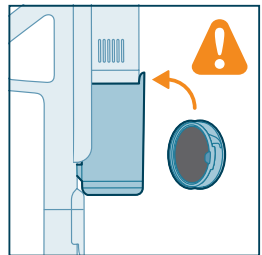
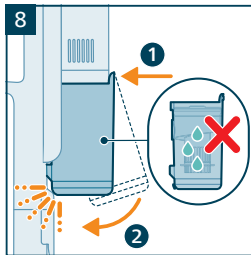
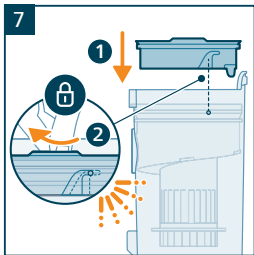
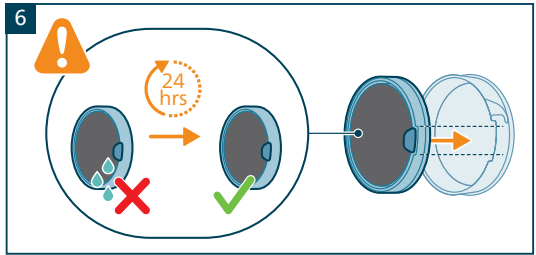
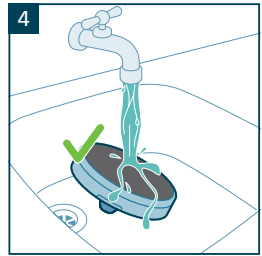
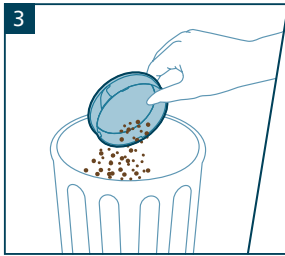
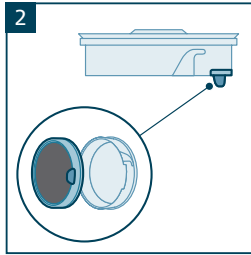
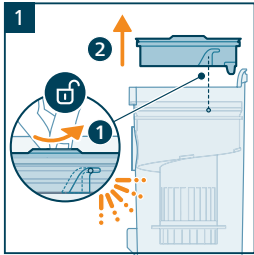



1

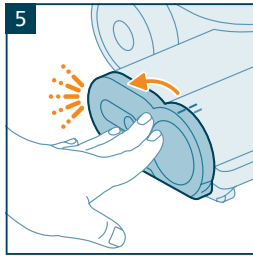
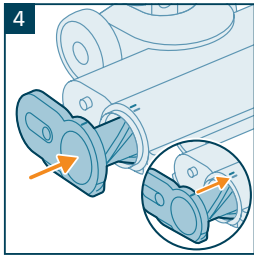
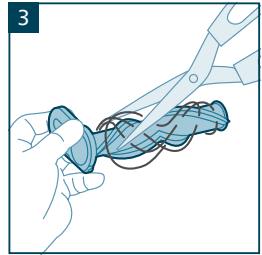
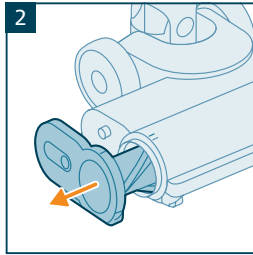
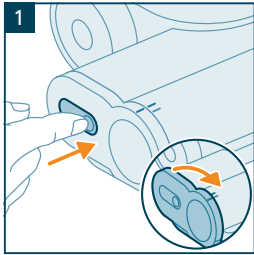

1

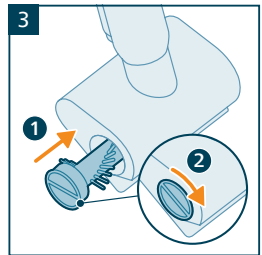
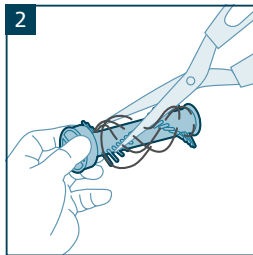
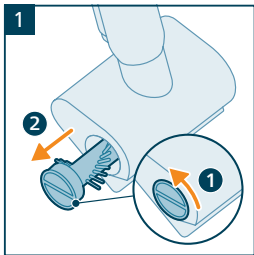

2

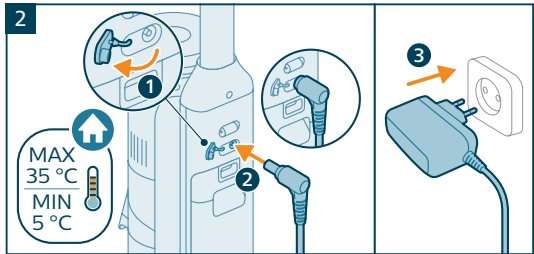
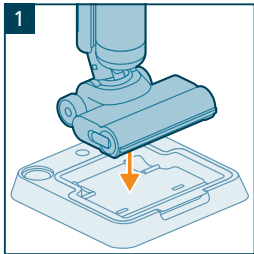

2

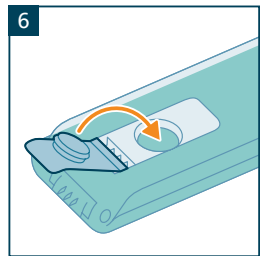
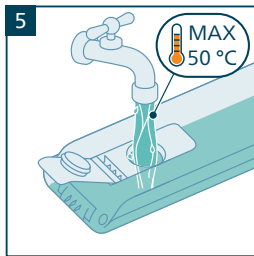
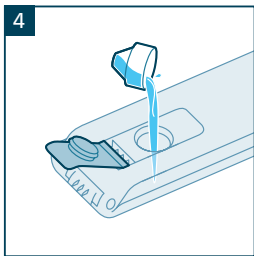
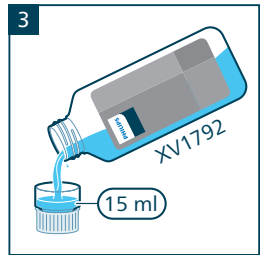
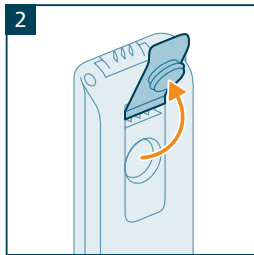
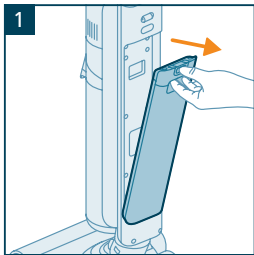

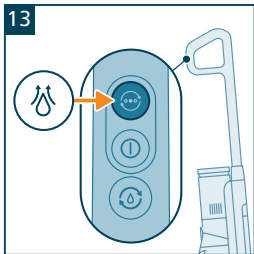
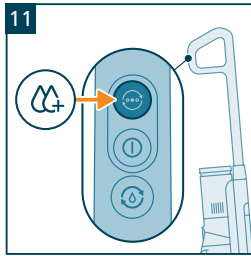
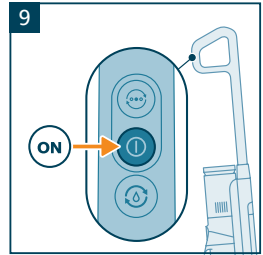
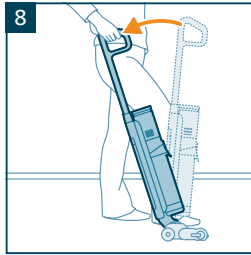
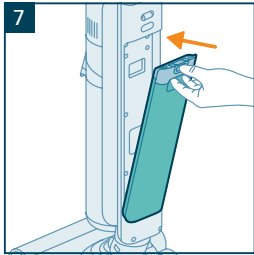

# 2

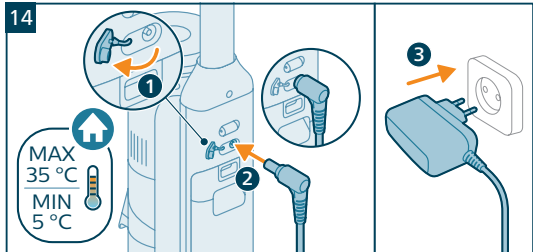
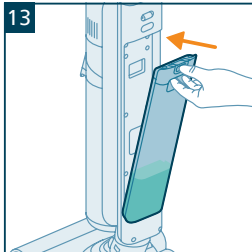
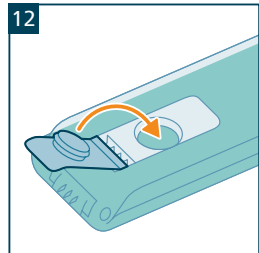
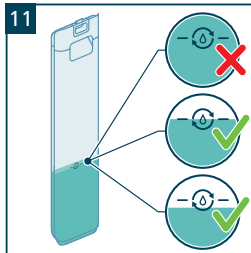
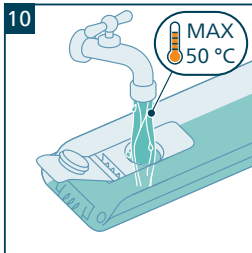
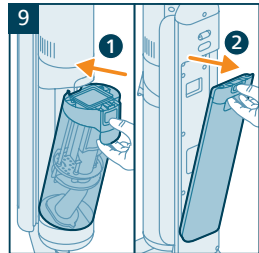
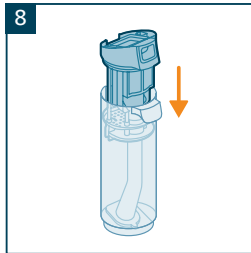
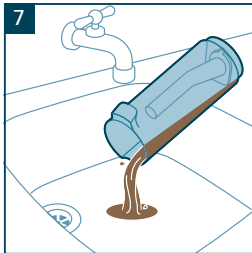
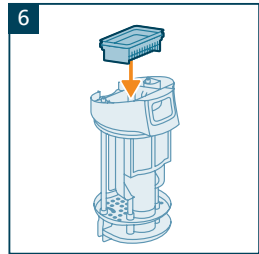
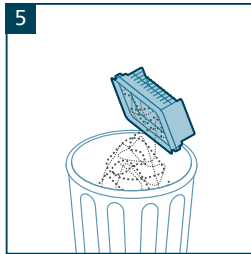
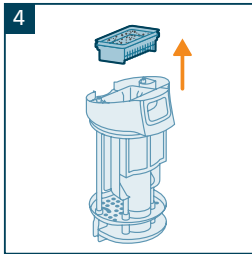
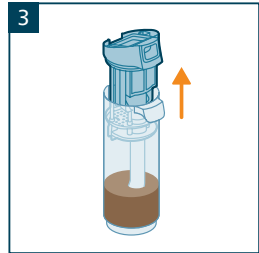
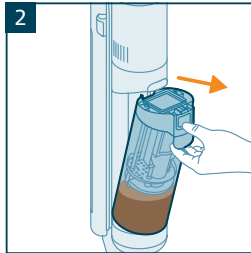
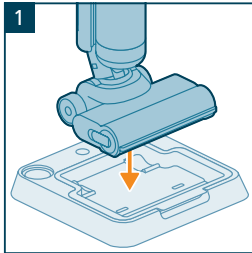

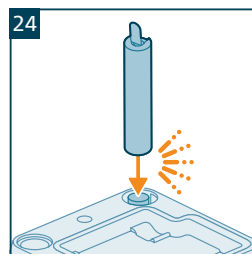
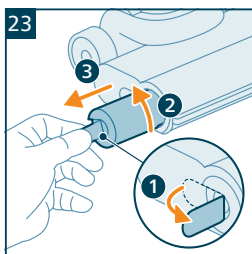
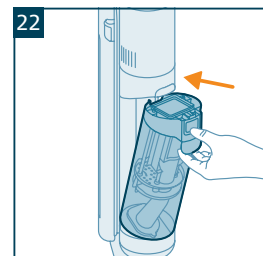
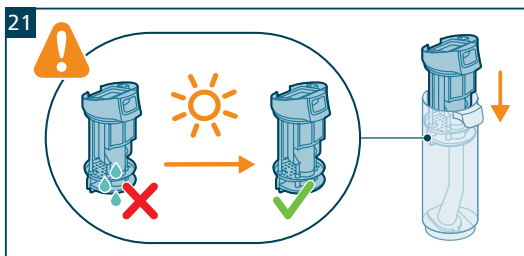
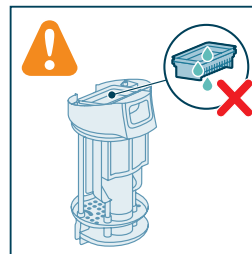
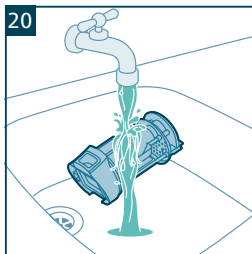
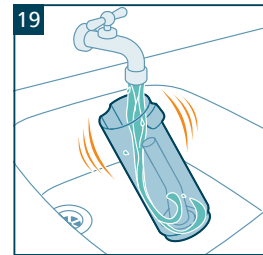
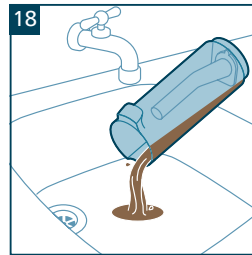
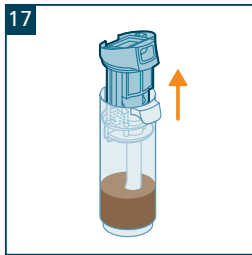
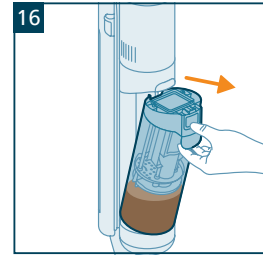
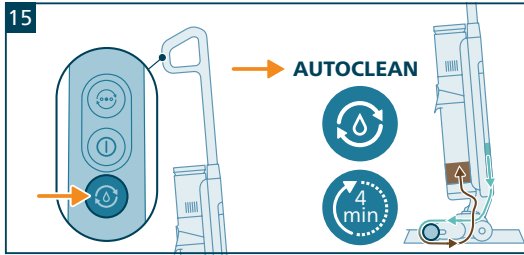



---

 <p><a href="http://www.philips.com/support">www.philips.com/support</a></p>
---

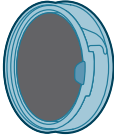
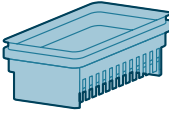
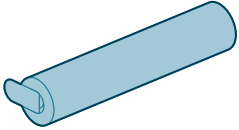
		
XV1770/10	XV1771/10	XV1773/10



<b>EN</b>	Welcome, Get started!
<b>BG</b>	Добре дошли, да започваме!
<b>CS</b>	Vítáme vás v sekci Začínáme!
<b>DA</b>	Velkommen, kom godt i gang!
<b>DE</b>	Willkommen! Legen Sie los!
<b>EL</b>	Καλωσήρθατε, ας ξεκινήσουμε!
<b>ES</b>	¡Hola, empecemos!
<b>ET</b>	Tere tulemast, alustage!
<b>FI</b>	Tervetuloa, aloitetaan!
<b>FR</b>	Bienvenue, débutez !
<b>HR</b>	Dobro došli, započnite!
<b>HU</b>	Üdvözlünk! Kezdjük is hozzá!
<b>IT</b>	Ti diamo il benvenuto. Iniziamo!

<b>KK</b>	Кош келдіңіз, ал бастайық!
<b>LT</b>	Sveiki, pradėkite naudoti!
<b>LV</b>	Laipei lūgti, viss gatavs lietošanai!
<b>NL</b>	Welkom, aan de slag!
<b>NO</b>	Velkommen, kom i gang!
<b>PL</b>	Witaj, zacznajmy!
<b>PT</b>	Bem-vindo, vamos começar!
<b>RO</b>	Bine ai venit, începe!
<b>RU</b>	Добро пожаловать, приступим!
<b>SK</b>	Vitajte, začíname!
<b>SL</b>	Dobrodošli, začnite!
<b>SQ</b>	Mirë se vini, fillojmë!
<b>SR</b>	Dobro došli, započnite!

<b>SV</b>	Välkommen. Nu sätter vi igång!
<b>TR</b>	Hoş geldiniz, haydi başlayalım!
<b>UK</b>	Вітаємо, розпочнімо!
<b>MK</b>	Добре дојдовте, започнете со употреба!
<b>ID</b>	Selamat datang, silakan memulai!
<b>KO</b>	환영합니다, 지금 시작하세요!
<b>MS</b>	Selamat datang, mari bermula!
<b>VI</b>	Chào mừng, Bắt đầu!
<b>SC</b>	歡迎您，讓我們開始吧！
<b>TC</b>	歡迎，馬上開始！
<b>FA</b>	اُهلا بك، تفضل وابدأ الاستخدام
<b>AR</b>	أهلا بك، تفضل وابدأ الاستخدام
<b>TH</b>	ยินดีต้อนรับ เริ่มใช้งานเลย!



<b>EN</b>	Registration and Benefits
<b>BG</b>	Регистрация и предимства
<b>CS</b>	Registrace a výhody
<b>DA</b>	Registrering og fordele
<b>DE</b>	Registrierung und Vorteile
<b>EL</b>	Δήλωση και πλεονεκτήματα
<b>ES</b>	Registro y ventajas
<b>ET</b>	Registreerimine ja eelised
<b>FI</b>	Rekisteröinti ja edut
<b>FR</b>	Enregistrement et avantages
<b>HR</b>	Registracija i prednosti
<b>HU</b>	Regisztráció és előnyök
<b>IT</b>	Registrazione e vantaggi

<b>KK</b>	Тиркелу және артықшылықтар
<b>LT</b>	Registracija ir privalumai
<b>LV</b>	Reģistrācija un priekšrocības
<b>NL</b>	Registratie en voordelen
<b>NO</b>	Registrering og fordeler
<b>PL</b>	Rejestracja i korzyści
<b>PT</b>	Registo e vantagens
<b>RO</b>	Înregistrare și beneficii
<b>RU</b>	Регистрация и преимущества
<b>SK</b>	Registrácia a výhody
<b>SL</b>	Registracija in ugodnosti
<b>SQ</b>	Regjistrimi dhe përfitimet
<b>SR</b>	Registracija i prednosti

<b>SV</b>	Registrering och fördelar
<b>TR</b>	Kayıt ve Avantajlar
<b>UK</b>	Рєєстрація та переваги
<b>MK</b>	Рєєстрација и повољности
<b>ID</b>	Pendaftaran dan Manfaat
<b>KO</b>	등록 및 혜택
<b>MS</b>	Pendaftaran dan Manfaat
<b>VI</b>	Đăng ký và Lợi ích
<b>SC</b>	注册和权益
<b>TC</b>	註冊與權益
<b>FA</b>	ثبت‌نام و فواید آن
<b>AR</b>	التسجيل والمزايا
<b>TH</b>	การลงทะเบียนและสิทธิประโยชน์



<b>EN</b>	Quick start
<b>BG</b>	Бърз старт
<b>CS</b>	Rychlý start
<b>DA</b>	Lynstart
<b>DE</b>	Schnellstart
<b>EL</b>	Σύντομος οδηγός
<b>ES</b>	Inicio rápido
<b>ET</b>	Kiirkäivitamine
<b>FI</b>	Pikaopas
<b>FR</b>	Démarrage rapide

<b>HR</b>	Brzo pokretanje
<b>HU</b>	Gyorsindítás
<b>IT</b>	Guida rapida
<b>KK</b>	Жылдам бастай
<b>LT</b>	Greitasis įjungimas
<b>LV</b>	Īsi norādījumi lietošanai
<b>NL</b>	Snel aan de slag
<b>NO</b>	Hurtigstart
<b>PL</b>	Szybki start
<b>PT</b>	Início rápido

<b>RO</b>	Pornire rapidă
<b>RU</b>	Начало работы
<b>SK</b>	Rýchle spustenie
<b>SL</b>	Hitri začetek
<b>SQ</b>	Hapat e parë
<b>SR</b>	Brzo pokretanje
<b>SV</b>	Snabbstart
<b>TR</b>	Hızlı başlangıç
<b>UK</b>	Короткий посібник
<b>MK</b>	Брз почеток

<b>ID</b>	Mulai cepat
<b>KO</b>	빠른 시작
<b>MS</b>	Mula pantas
<b>VI</b>	Hướng dẫn sử dụng nhanh
<b>SC</b>	快速入门
<b>TC</b>	快速入門
<b>FA</b>	شروع سریع
<b>AR</b>	البدا السريع
<b>TH</b>	เริ่มต้นด่วน



<b>EN</b>	Digital manual
<b>BG</b>	Дигитално ръководство
<b>CS</b>	Digitální příručka
<b>DA</b>	Digital manual
<b>DE</b>	Digitales Handbuch
<b>EL</b>	Ψηφιακό εγχειρίδιο
<b>ES</b>	Manual digital
<b>ET</b>	Digitaalne kasutusjuhend
<b>FI</b>	Digitaalinen käyttöopas
<b>FR</b>	Manuel numérique

<b>HR</b>	Digitalni priručnik
<b>HU</b>	Digitális kézikönyv
<b>IT</b>	Manuale digitale
<b>KK</b>	Цифрлық нұсқаулық
<b>LT</b>	Skaitmeninis vadovas
<b>LV</b>	Digitālā rokasgrāmata
<b>NL</b>	Digitale handleiding
<b>NO</b>	Digital håndbok
<b>PL</b>	Elektroniczna instrukcja obsługi
<b>PT</b>	Manual digital

<b>RO</b>	Manual digital
<b>RU</b>	Цифровое руководство
<b>SK</b>	Digitálna príručka
<b>SL</b>	Digitalni priročnik
<b>SQ</b>	Manuali digital
<b>SV</b>	Digitalno uputstvo
<b>TR</b>	Dijital anıvandarhandbok
<b>TR</b>	Dijital kılavuz
<b>UK</b>	Цифровий посібник
<b>MK</b>	Дигитално упатство

<b>ID</b>	Manual digital
<b>KO</b>	디지털 설명서
<b>MS</b>	Manual digital
<b>VI</b>	Hướng dẫn kỹ thuật số
<b>SC</b>	数字手册
<b>TC</b>	數位手冊
<b>FA</b>	راهنمای دیجیتال
<b>AR</b>	الدليل الرقمي
<b>TH</b>	คู่มือดิจิทัล

